



SUMMIT MAKALU



SUMMIT PUMORI



SUMMIT AMA

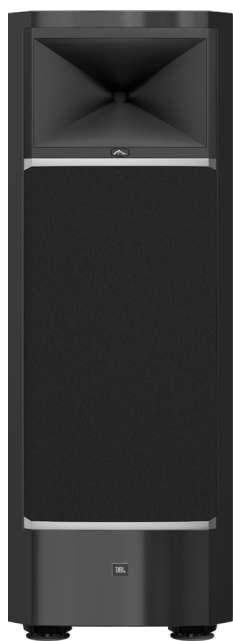
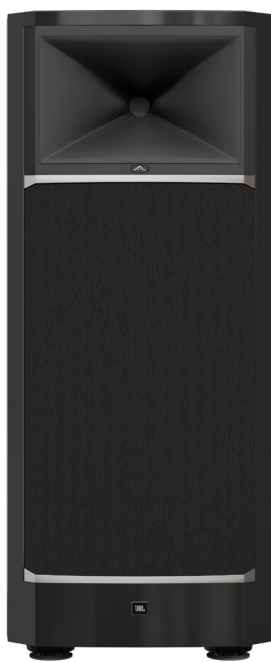



## Welcome to Summit

Thank you for selecting a JBL Summit Series loudspeaker system. These loudspeakers are the culmination of our research and development efforts in sound reproduction over the last 80 years. We believe that the Summit Series represents the best possible family of loudspeakers that can be built with current technology, with the aim of creating loudspeaker systems free from acoustical or electrical limitations.

This Quick Start Guide contains the necessary background information and instructions for safely unpacking and setting up your JBL Summit Series loudspeakers. The models included in this guide are the floor-standing Summit Makalu and Summit Pumori, and the stand-mount Summit Ama. This guide will review general safety precautions, unboxing, in-room positioning, making the connections to associated electronics, leveling, and general care & cleaning.

For a deeper understanding of the unique design and technical features incorporated in your JBL Summit Series loudspeaker, we encourage you to visit your respective model's product page at [www.jblsummit.com](http://www.jblsummit.com) or to contact a member of our Customer Support Team in the Americas at +1-888-691-4171 or Internationally at +44-1707-668-012.

[www.jblsummit.com](http://www.jblsummit.com)



## Safety Notes

- ⚠ All JBL Summit Series speakers have substantial mass. DO NOT attempt to lift or move the loudspeaker without adequate assistance. The shipping weight of these models exceeds what a single person should lift alone. To avoid injury to oneself or damage to the loudspeaker, at least two people are required to lift or move these loudspeakers.
- ⚠ Please ensure that your JBL Summit Series loudspeakers stand on solid flooring and that the JBL | IsoAcoustic<sup>®</sup> feet are properly adjusted / leveled when the loudspeaker is in its final in-room position.
- ⚠ DO NOT overtighten screws or speaker binding posts.
- ⚠ Ensure that all electrical components that will be connected to these loudspeakers are turned OFF and unplugged from electrical outlets prior to connecting them to the loudspeakers.
- ⚠ When powering up the electronics connected to the loudspeakers, verify that the volume is set to a low level and bring up the volume slowly to avoid potential damage.
- ⚠ If you are unclear on how to proceed safely, please seek professional guidance.

## Package Contents

### Summit Makalu

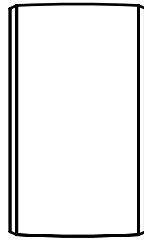

### Summit Pumori

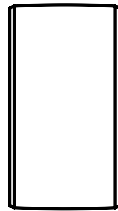

### Summit Ama

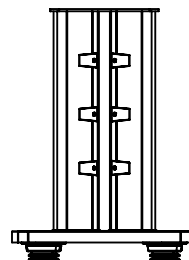
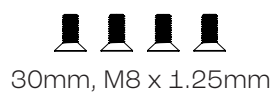
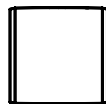

### Summit Makalu and Summit Pumori Unboxing & Setup

1

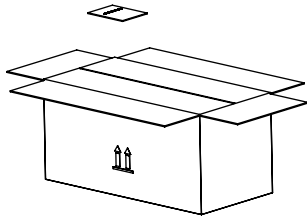

2

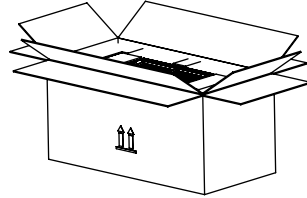

3

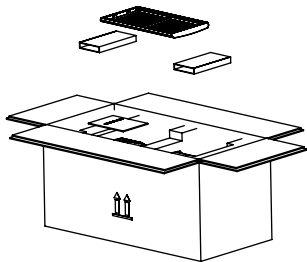

4

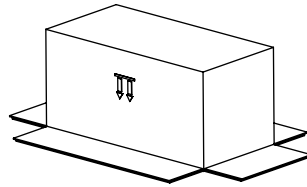

5

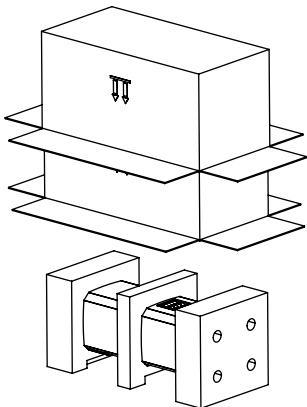

6

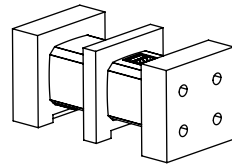

7

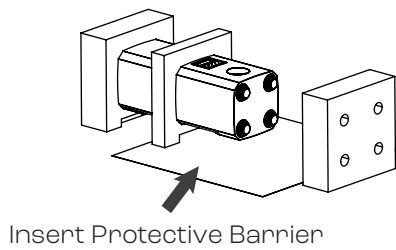

8

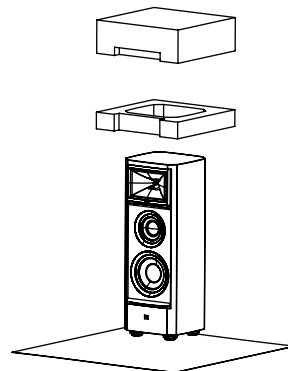

9

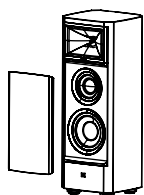

10

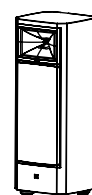

3

### Summit Ama Unboxing & Setup

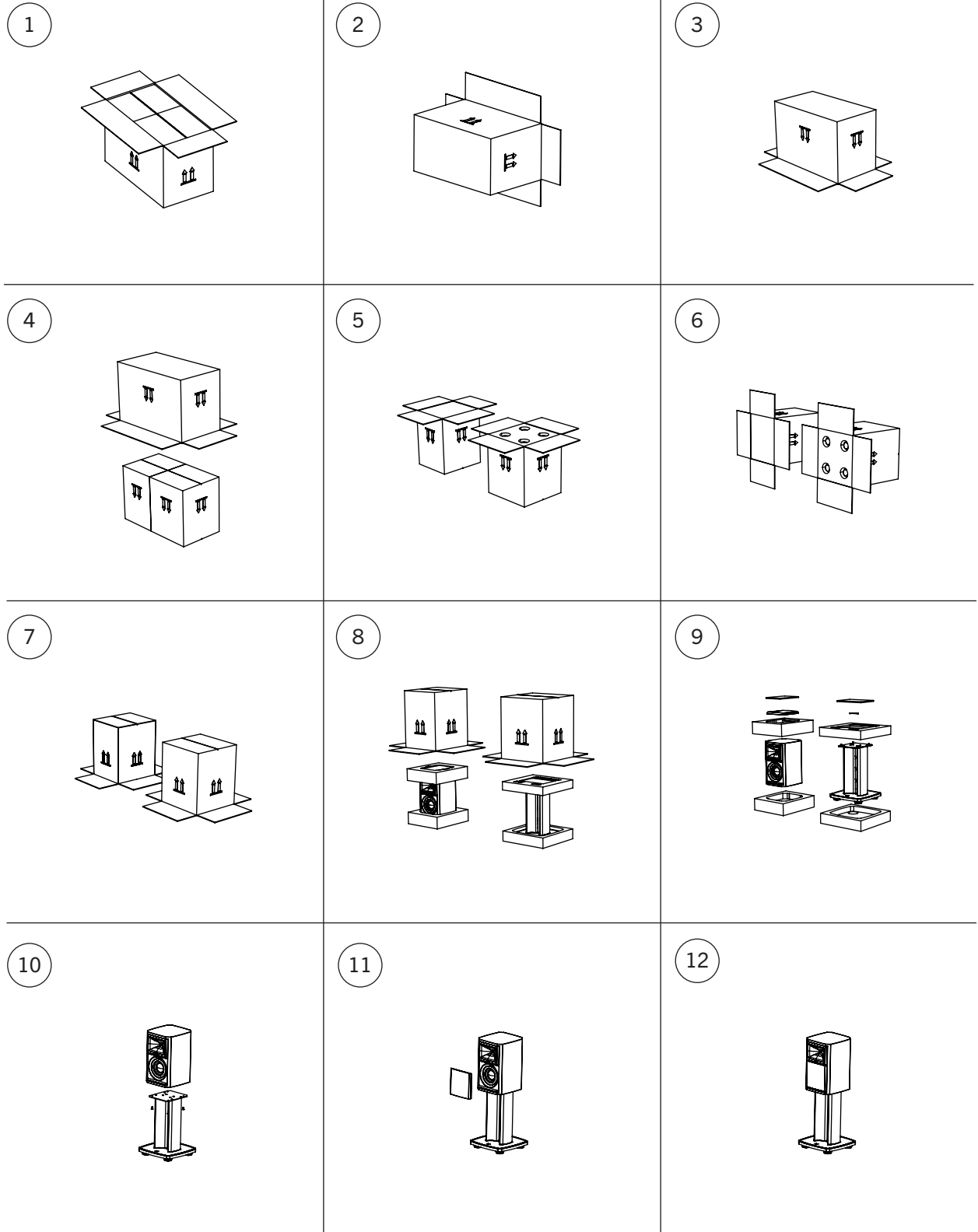

### Summit Ama Pedestal Mounting

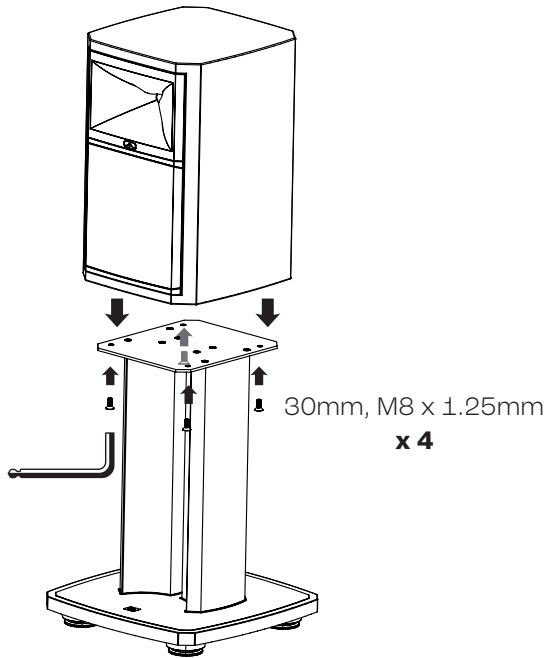

### Layout

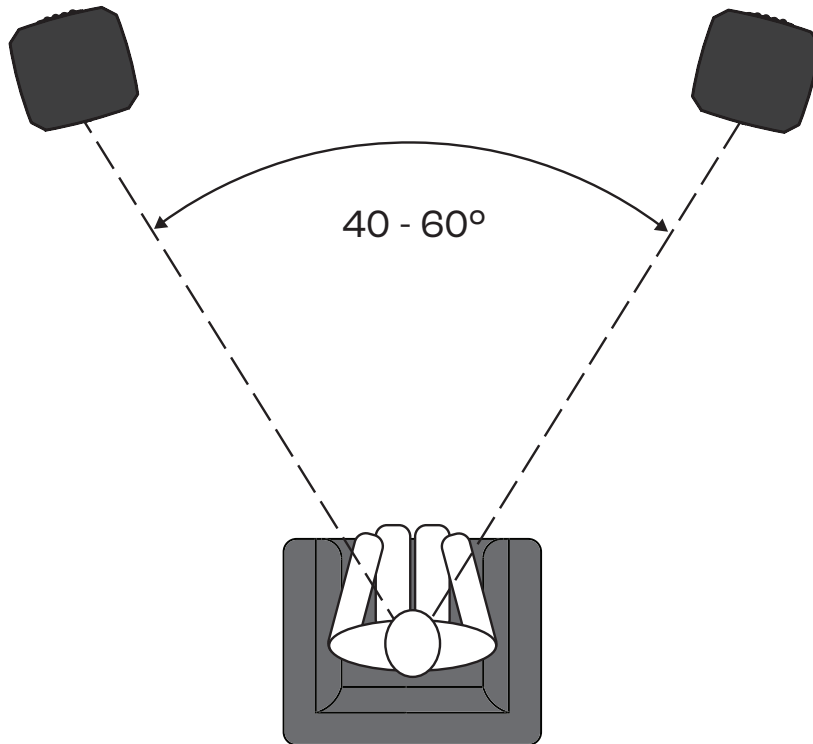

## Configuration & Connections

### Single-Ended

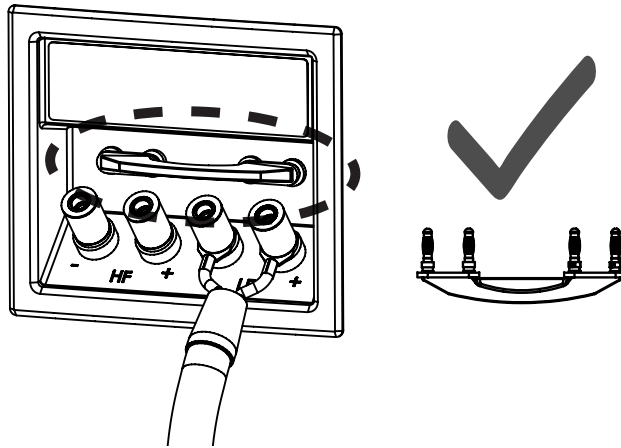

### Bi-wire / Bi-Amped

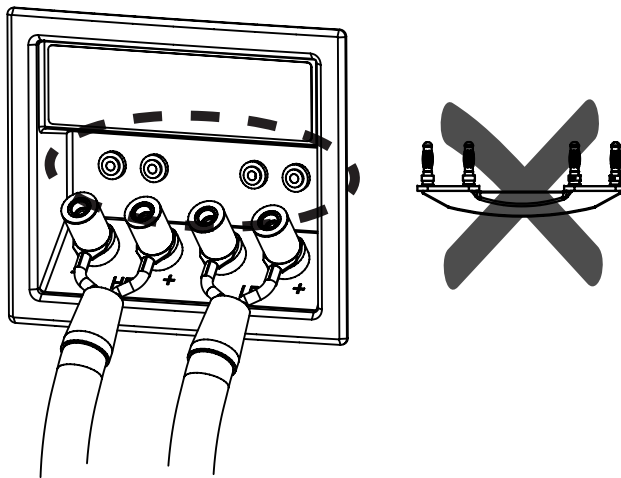

### Summit Ama Cable Management

1

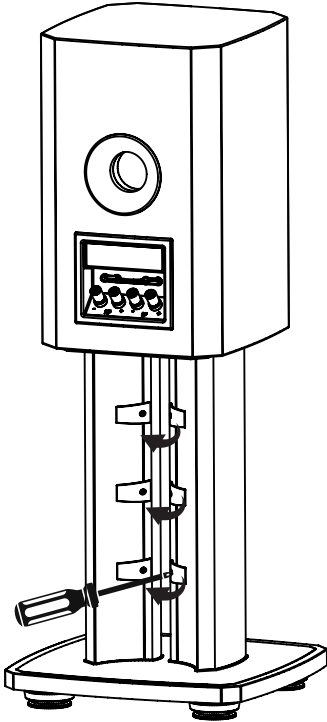

2

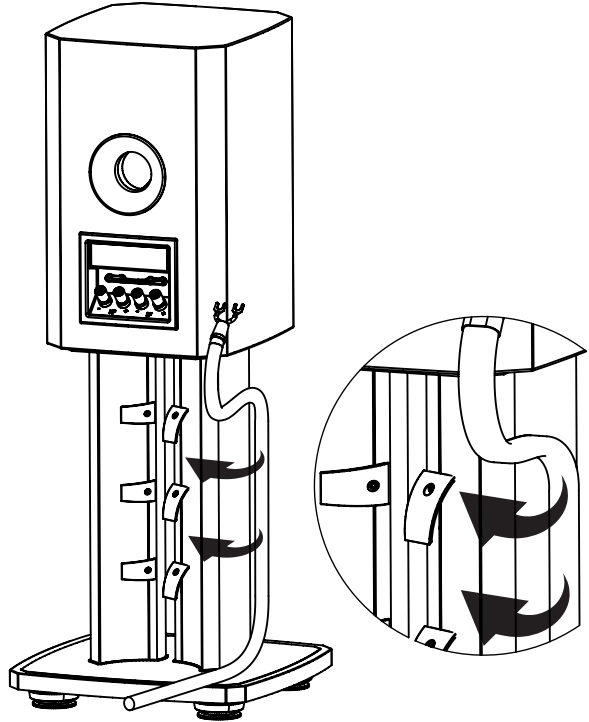

3

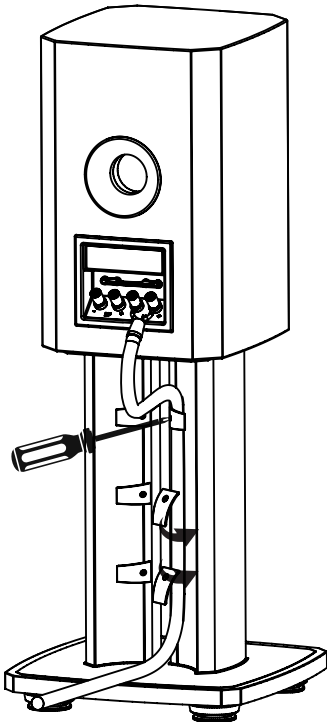

4

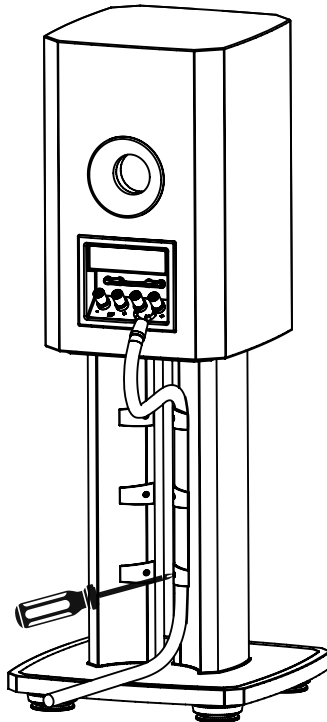

## Speaker Leveling using IsoAcoustics® Feet

To extend foot



To retract foot



[www.isoacoustics.com](http://www.isoacoustics.com)



## Care Instructions

- ⌚ Excess heat, sunlight and/or moisture may result in damage to the product.
- ⌚ Regularly clean the exterior with a soft micro-fiber cloth.
- ⌚ Avoid using harsh chemicals or excessive moisture when cleaning.
- ⌚ To clean the grille, first remove it from the speaker. Next, carefully use a vacuum with a soft brush attachment to remove any dust and debris.
- ⌚ Never use liquid cleaners on any of the transducers.
- ⌚ Never use compressed air on any of the transducers, especially the compression driver.
- ⌚ If ever in doubt, please contact our Customer Support team for assistance.



## Bienvenue à Summit

Merci de choisir un système d'enceintes JBL de la série Summit. Ces enceintes sont l'aboutissement de nos efforts de recherche et développement en reproduction sonore au cours des 80 dernières années. Nous pensons que la série Summit représente la meilleure famille d'enceintes possible pouvant être construite avec la technologie actuelle, dans le but de créer des systèmes d'enceintes exempts de limitations acoustiques et électriques.

Ce Guide de démarrage rapide contient les informations de base et les instructions nécessaires pour déballer et configurer en toute sécurité vos enceintes JBL de la série Summit. Les modèles décrits dans ce guide sont les colonnes Summit Makalu et Summit Pumori ainsi que le modèle sur pied Summit Ama. Ce guide examinera les précautions générales de sécurité, le déballage, le positionnement dans la pièce, les connexions à l'électronique associée, le nivellement, les soins et le nettoyage généraux.

Pour une meilleure compréhension de la conception et des caractéristiques techniques uniques incorporées dans vos enceintes JBL série Summit, nous vous encourageons à visiter la page de produit de votre modèle respectif sur [www.jblsummit.com](http://www.jblsummit.com) ou à contacter un membre de notre équipe de support clientèle des Amériques au +1-888-691-4171 ou internationale au +44-1707-668-012.

[www.jblsummit.com](http://www.jblsummit.com)



## Consignes de sécurité

- 9 Toutes les enceintes de la série Summit de JBL ont une masse conséquente. **NE TENTEZ PAS** de soulever ou de déplacer l'enceinte sans une assistance adéquate. Le poids brut de ces modèles dépasse ce qu'une personne peut soulever seule. Pour éviter des blessures ou des dommages à l'appareil, au moins deux personnes sont nécessaires pour soulever ou déplacer ces enceintes.
- 9 Vérifiez que vos enceintes JBL série Summit sont posées sur un sol solide et que les pieds JBL | IsoAcoustic<sup>®</sup> sont correctement réglés / de niveau lorsque l'enceinte est à sa position finale dans la pièce.
- 9 **NE SERREZ PAS EXCESSIVEMENT** les vis et les bornes de l'enceinte.
- 9 S'assurer que tous les composants électriques qui seront connectés à ces enceintes sont éteints et débranchés des prises électriques avant de les connecter aux enceintes.
- 9 Lors de la mise sous tension de l'électronique connectée aux enceintes, vérifiez que le volume est réglé à un niveau bas et augmenter le volume lentement pour éviter des dommages potentiels.
- 9 Si vous ne savez pas exactement comment procéder en toute sécurité, demandez conseil à un professionnel.

## Contenu de l'emballage

### Summit Makalu

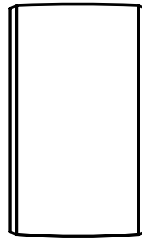

### Summit Pumori

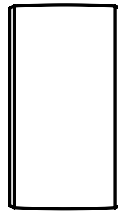

### Summit Ama

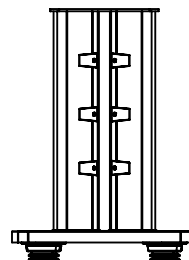
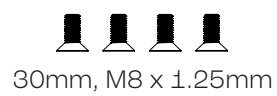
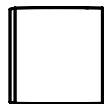

### Summit Makalu et Summit Pumori Déballage et mise en place

1

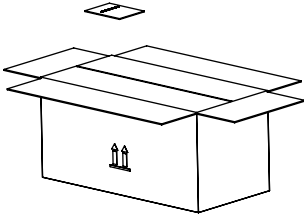

2

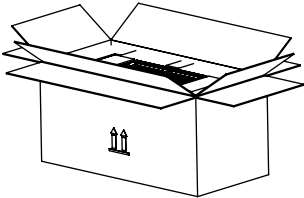

3

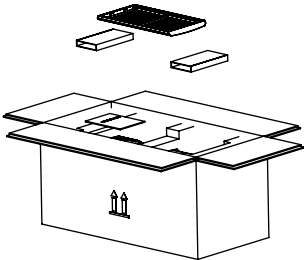

4

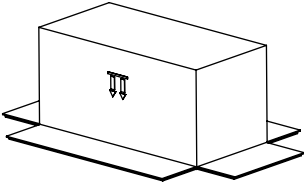

5

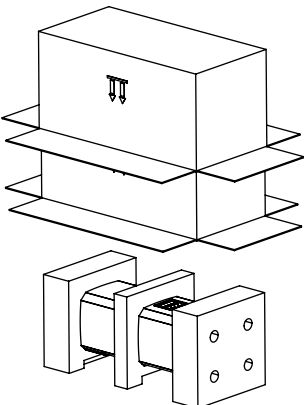

6

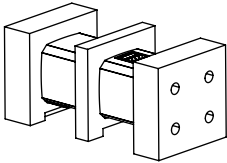

7

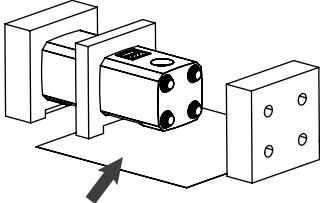

Insérer une barrière de protection

8

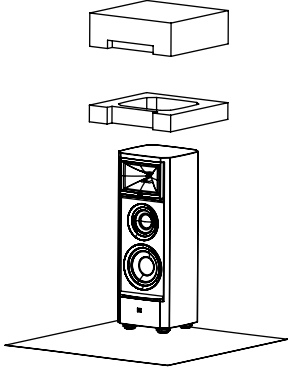

9

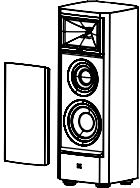

10

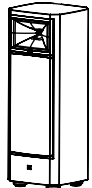

## Summit Ama Déballage et installation

1

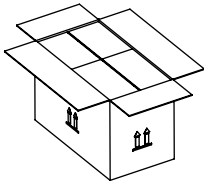

2

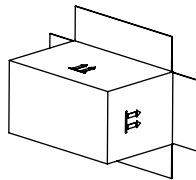

3

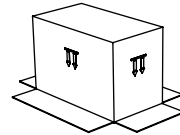

4

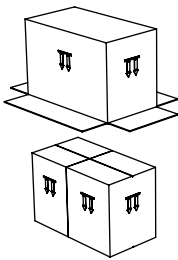

5

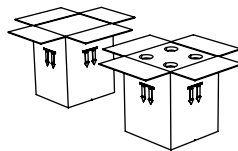

6

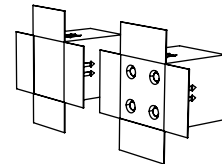

7

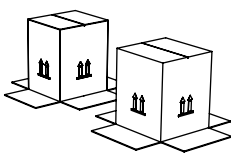

8

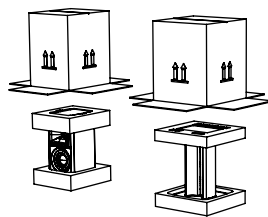

9

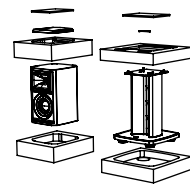

10

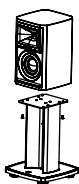

11



12

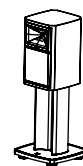

### Montage du pied pour Summit Ama

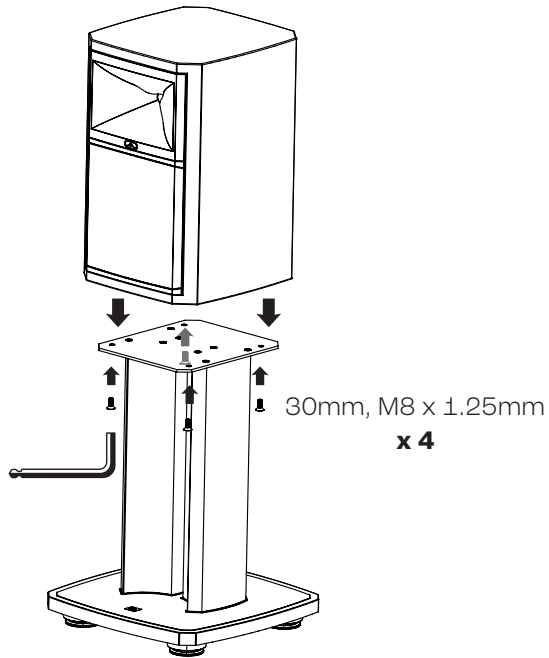

### Disposition

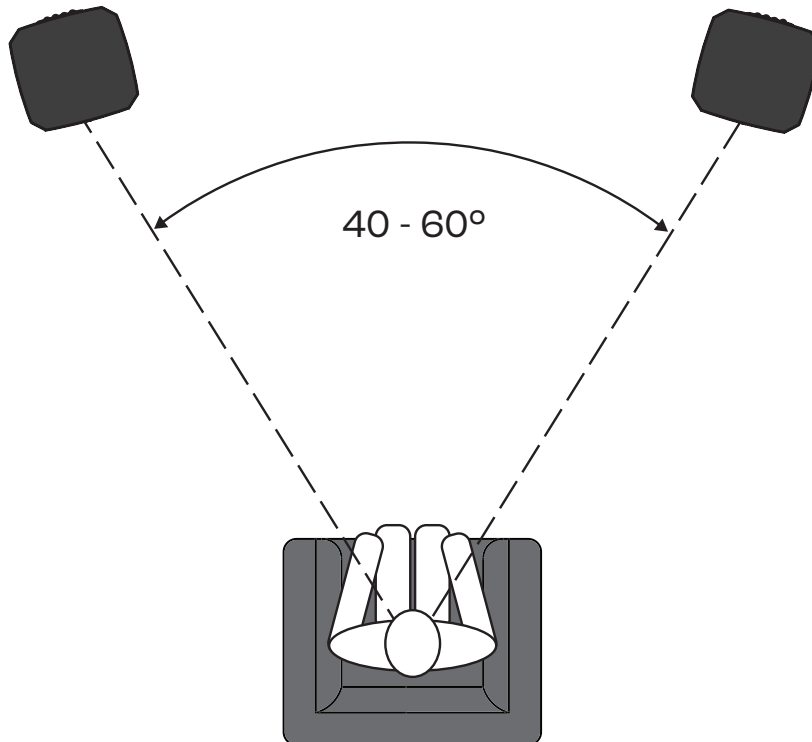

## Configuration et connexion

### Câblage unique

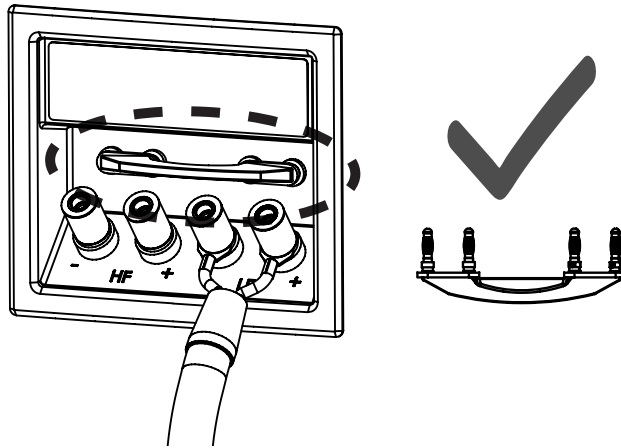

### Bicâblage / Bi-amplification

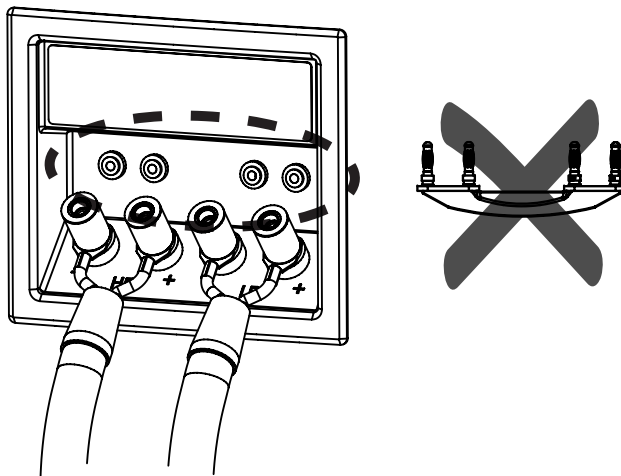

### Summit Ama Gestion des câbles

1

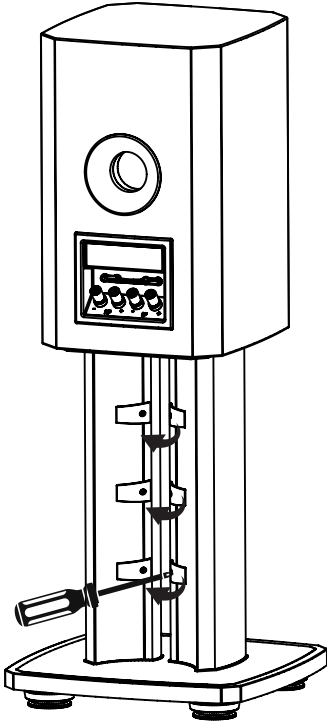

2

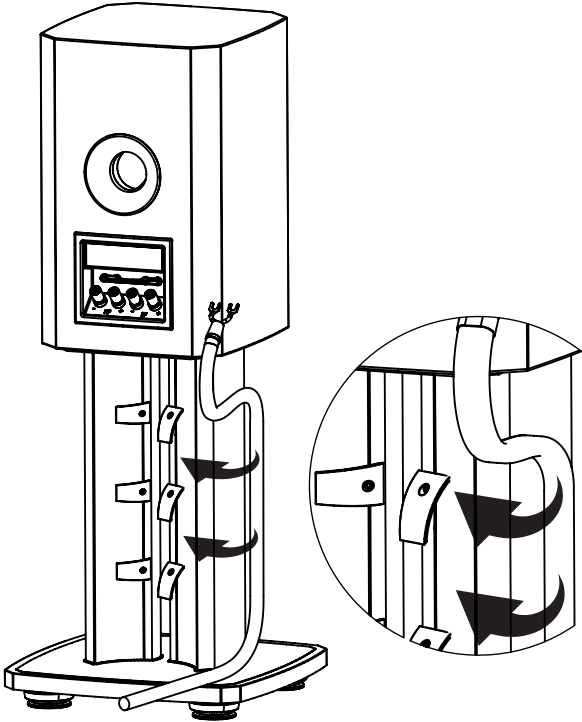

3

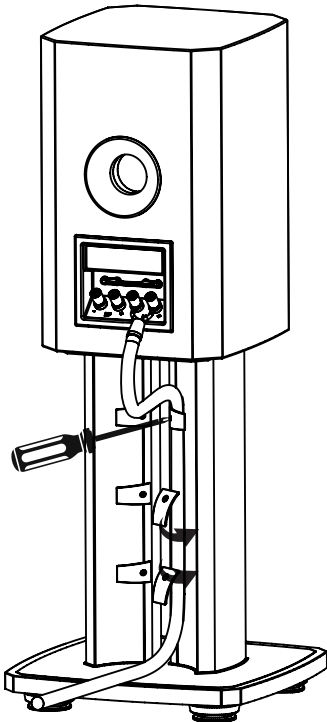

4

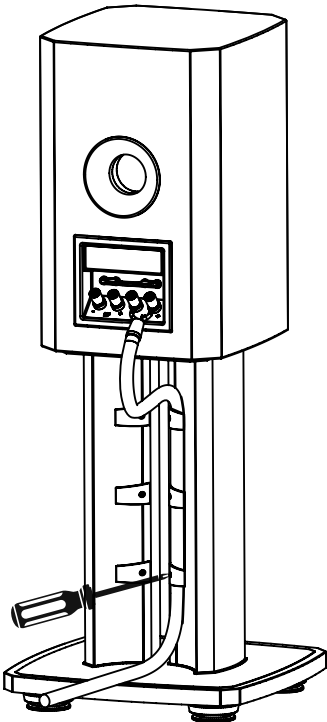

## Mise de niveau de l'enceinte avec les pieds IsoAcoustics®

Extension du pied



Rétraction du pied



[www.isoacoustics.com](http://www.isoacoustics.com)



## Consignes d'entretien

- Ⓜ L'excès de chaleur, de soleil et/ou d'humidité peut causer des dommages au produit.
- Ⓜ Nettoyer régulièrement l'extérieur avec un chiffon doux en microfibre.
- Ⓜ Éviter d'utiliser des produits chimiques agressifs ou une humidité excessive lors du nettoyage.
- Ⓜ Pour nettoyer la grille, la retirer d'abord de l'enceinte. Ensuite, utiliser un aspirateur avec précaution et une brosse souple pour retirer la poussière et les débris.
- Ⓜ Ne jamais utiliser de nettoyant liquide sur les transducteurs.
- Ⓜ Ne jamais utiliser d'air comprimé sur aucun des transducteurs, en particulier le haut-parleur de compression.
- Ⓜ En cas de doute, veuillez contacter notre équipe de support clientèle.



## Te damos la bienvenida a Summit

Gracias por elegir un sistema de altavoces JBL de la serie Summit. Estos altavoces son la culminación de nuestros esfuerzos de investigación y desarrollo en reproducción de sonido a lo largo de los últimos 80 años. Creemos que la serie Summit representa la mejor familia de altavoces que se puede crear con la tecnología actual, con el objetivo de crear sistemas de altavoces sin limitaciones acústicas ni eléctricas.

Esta guía de inicio rápido incluye la información básica y las instrucciones necesarias para desembalar e instalar de forma segura tus altavoces JBL de la serie Summit. Los modelos que se incluyen en esta guía son los Summit Makalu y Summit Pumori de suelo, y el Summit Ama de montaje sobre pedestal. Esta guía trata las precauciones generales de seguridad, el desembalaje, la colocación en la sala, la conexión de los componentes electrónicos, la nivelación y el cuidado y la limpieza generales.

Para entender mejor el diseño único y las características técnicas que incorpora su altavoz JBL de la serie Summit, te recomendamos visitar la página del producto de tu modelo correspondiente en [www.jblsummit.com](http://www.jblsummit.com) o ponerte en contacto con un miembro de nuestro equipo de atención al cliente en las Américas en el +1-888-691-4171 o en todo el mundo en el +44-1707-668-012.

[www.jblsummit.com](http://www.jblsummit.com)



## Notas de seguridad

- ⚠ Todos los altavoces JBL de la serie Summit tienen un peso considerable. NO intentes levantar o mover el altavoz sin la ayuda adecuada. El peso de envío de estos modelos excede lo que una sola persona debería levantar sola. Para evitar lesiones personales o daños en el altavoz, se necesitan por lo menos dos personas para levantar o mover estos altavoces.
- ⚠ Asegúrate de que los altavoces JBL de la serie Summit estén sobre un suelo firme y de que las patas JBL | IsoAcoustic<sup>®</sup> estén correctamente ajustadas/niveladas cuando el altavoz esté en su posición final en la sala.
- ⚠ NO aprietes en exceso los tornillos ni los bornes de conexión del altavoz.
- ⚠ Asegúrate de que todos los componentes eléctricos que se conectarán a estos altavoces estén apagados y desenchufados de las tomas de corriente antes de conectarlos.
- ⚠ Al encender los componentes electrónicos conectados a los altavoces, comprueba que el volumen esté bajo y súbelo poco a poco para evitar posibles daños.
- ⚠ Si no tienes claro cómo proceder de forma segura, busca orientación profesional.

## Contenido del envase

### Summit Makalu

Guía de inicio rápido

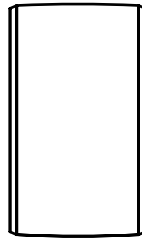
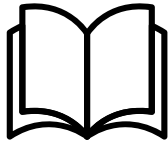

### Summit Pumori

Guía de inicio rápido

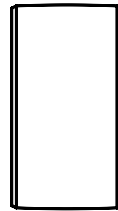

### Summit Ama

Guía de inicio rápido

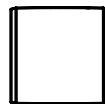

30mm, M8 x 1.25mm

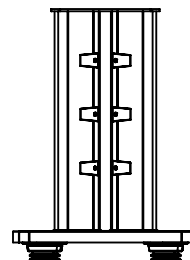

### Summit Makalu y Summit Pumori Desembalaje e instalación

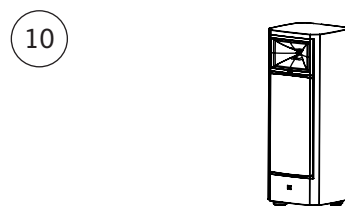
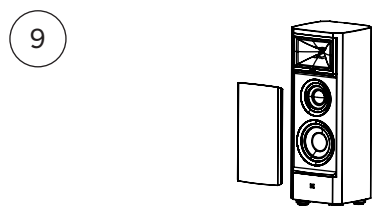
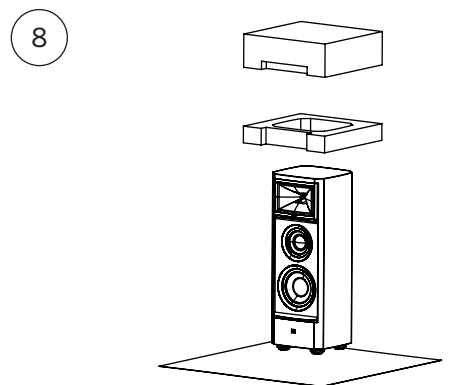
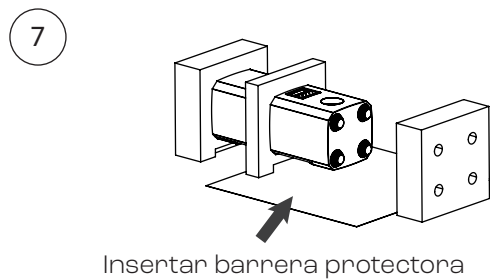
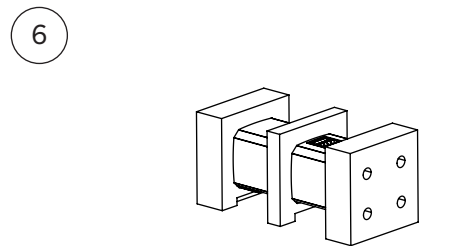
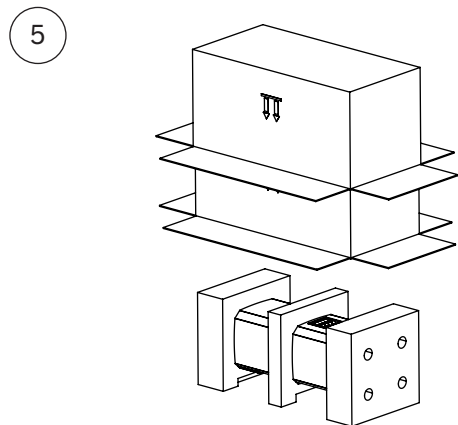
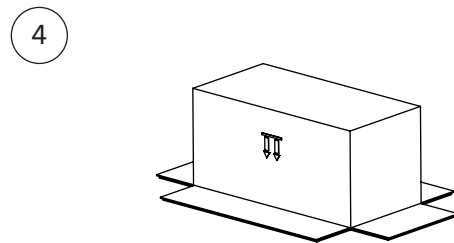
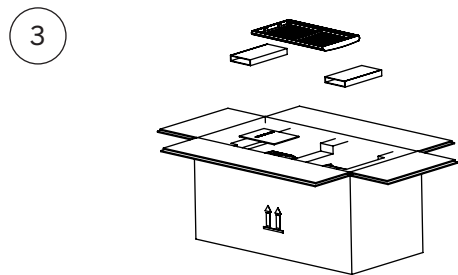
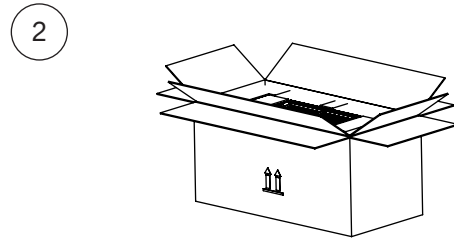
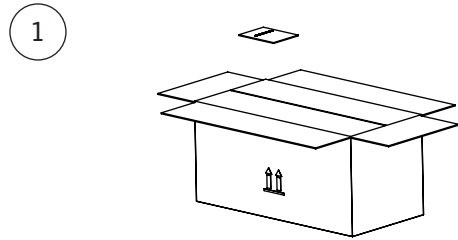

## Summit Ama Desembalaje e instalación

1

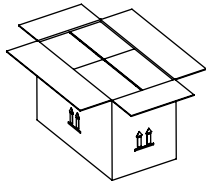

2

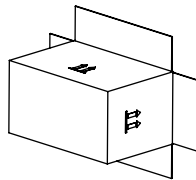

3

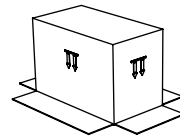

4

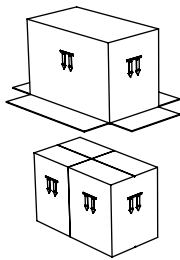

5

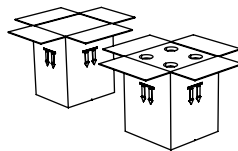

6

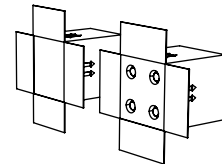

7

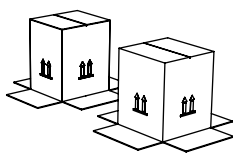

8

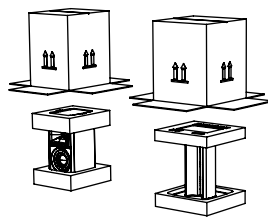

9

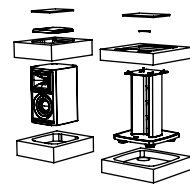

10

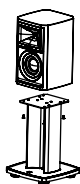

11

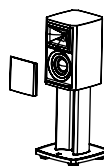

12

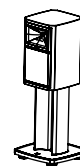

### Montaje del pedestal Summit Ama

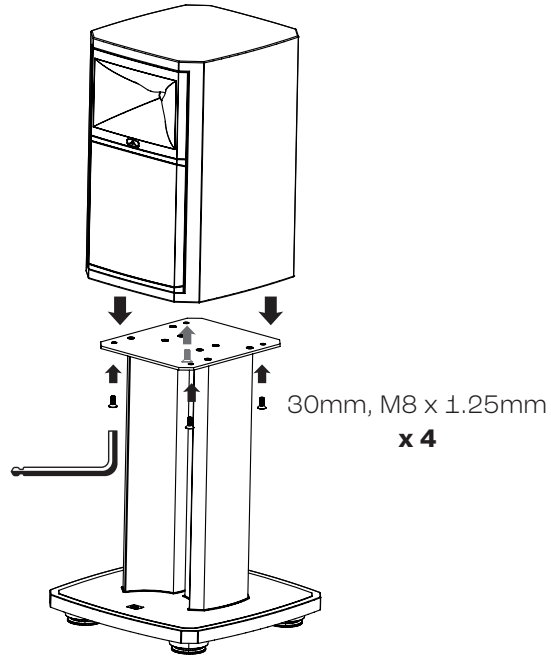

### Diseño

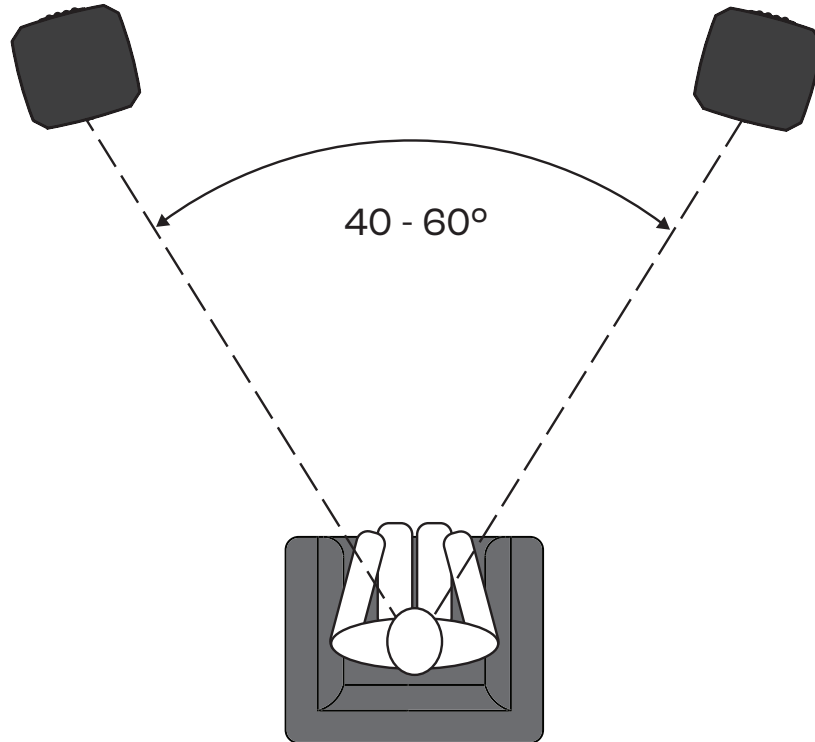

## Configuración y conexiones

### Una sola terminación

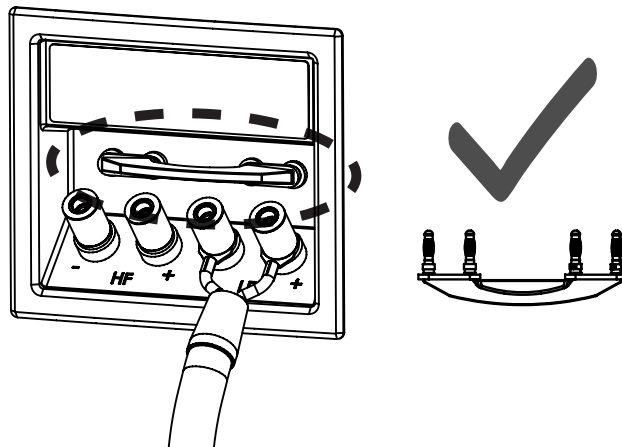

### Bicableado/Biamplicado

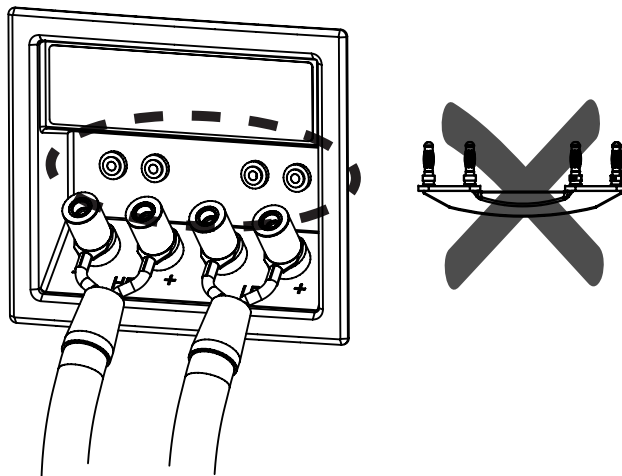

### Summit Ama Gestión de cables

1

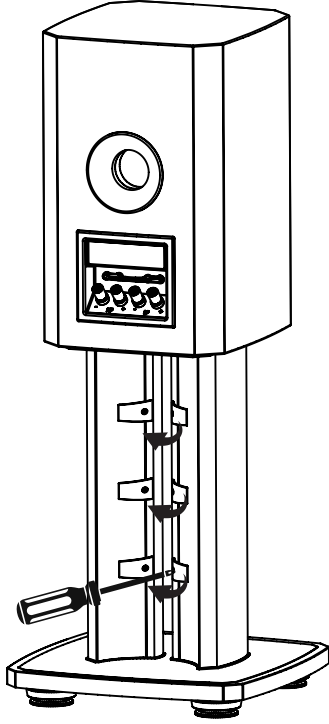

2

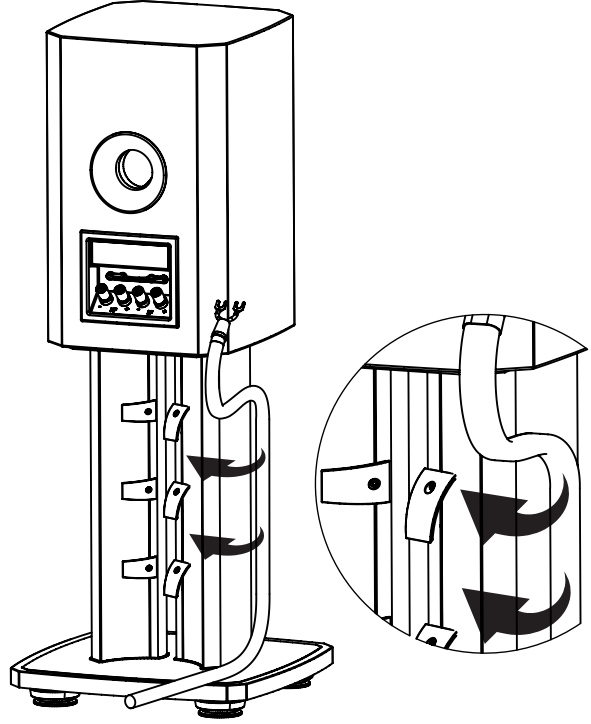

3

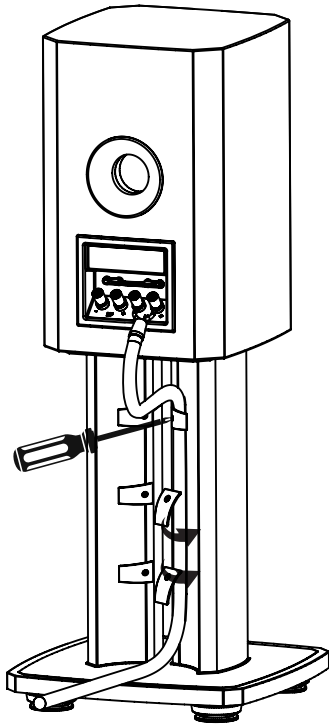

4

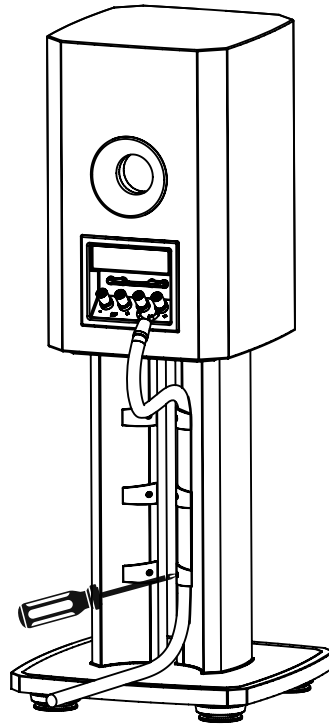

## Nivelación de altavoces con patas IsoAcoustics®

Para extender la pata



Para retraer la pata



[www.isoacoustics.com](http://www.isoacoustics.com)



## Instrucciones de cuidado

- ⦿ El calor excesivo, la luz solar y/o la humedad pueden dañar el producto.
- ⦿ Limpia el exterior con frecuencia con un paño suave de microfibra.
- ⦿ Evita utilizar productos químicos agresivos o humedad excesiva al limpiar.
- ⦿ Para limpiar la rejilla, primero retírala del altavoz. Luego, usa con cuidado una aspiradora con un cepillo suave para eliminar el polvo y los residuos.
- ⦿ Nunca uses limpiadores líquidos en los transductores.
- ⦿ Nunca utilices aire comprimido en los transductores, sobre todo en la unidad de compresión.
- ⦿ Si tienes dudas, ponte en contacto con nuestro equipo de atención al cliente para obtener ayuda.



## Willkommen bei Summit

Vielen Dank, dass Sie sich für ein Lautsprechersystem der JBL Summit-Serie entschieden haben. Diese Lautsprecher sind der Höhepunkt unserer Forschungs- und Entwicklungsanstrengungen im Bereich der Tonwiedergabe in den letzten 80 Jahren. Wir sind überzeugt, dass die Summit-Serie die bestmögliche Lautsprecher-Familie darstellt, die mit der aktuellen Technologie mit dem Ziel umgesetzt werden kann, Lautsprechersysteme zu bauen, die frei von akustischen oder elektrischen Einschränkungen sind.

Diese Kurzanleitung enthält die notwendigen Hintergrundinformationen und Anweisungen für das sichere Auspacken und Aufstellen der Lautsprecher der JBL Summit-Serie. Die in dieser Anleitung vorgestellten Modelle sind die Standmodelle Summit Makalu und Summit Pumori sowie das Standmodell Summit Ama. In dieser Anleitung werden allgemeine Sicherheitsvorkehrungen, das Auspacken, die Positionierung im Raum, das Herstellen der Verbindungen zur zugehörigen Elektronik, das Ausrichten sowie die allgemeine Pflege und Reinigung behandelt.

Für ein tieferes Verständnis des einzigartigen Designs und der technischen Merkmale der Lautsprecher der JBL Summit-Serie empfehlen wir, die Produktseite des jeweiligen Modells unter [www.jblsummit.com](http://www.jblsummit.com) zu besuchen oder unser Kundendienst-Team in den USA unter +1-888-691-4171 oder international unter +44-1707-668-012 zu kontaktieren.

[www.jblsummit.com](http://www.jblsummit.com)



## Sicherheitshinweise

- ⚠ Alle Lautsprecher der JBL Summit-Serie verfügbaren über ein beträchtliches Gewicht. Bitte NICHT versuchen, den Lautsprecher ohne adäquate Hilfe anzuheben oder zu transportieren. Das Gewicht dieses Modells überschreitet den Grenzwert der Tragkraft einer einzelnen Person. Zum Heben oder Transportieren des Lautsprechers sind mindestens zwei Personen erforderlich, um Verletzungen oder Schäden an diesen Lautsprechern zu vermeiden.
- ⚠ Bitte sicherstellen, dass die Lautsprecher der JBL Summit-Serie auf einem festen Boden stehen und dass die JBL | IsoAcoustic<sup>®</sup>-Füße an der endgültigen Position des Lautsprechers im Raum korrekt eingestellt bzw. nivelliert sind.
- ⚠ Die Schrauben oder die Lautsprecheranschlussklemmen NICHT zu fest anziehen.
- ⚠ Bitte überprüfen, ob alle elektrischen Komponenten, die an die Lautsprecher angeschlossen werden, AUSGESCHALTET und von den Steckdosen getrennt sind, bevor sie mit den Lautsprechern verbunden werden.
- ⚠ Beim Einschalten der mit den Lautsprechern verbundenen Elektronik ist darauf zu achten, dass die Lautstärke auf einen niedrigen Pegel eingestellt ist, und die Lautstärke danach nur langsam wird, um mögliche Schäden zu vermeiden.
- ⚠ Falls Sie sich nicht sicher sind, wie Sie vorgehen sollen, lassen Sie sich bitte von einem Fachmann beraten.

## Lieferumfang

### Summit Makalu

Kurzanleitung

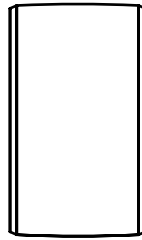

### Summit Pumori

Kurzanleitung

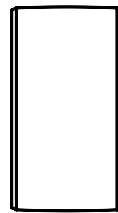
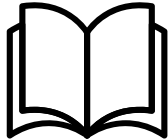

### Summit Ama

Kurzanleitung

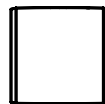

30mm, M8 x 1.25mm

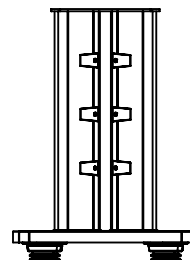

### Summit Makalu und Summit Pumori Auspacken und Einrichten

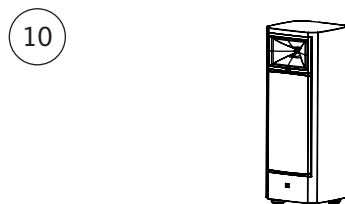
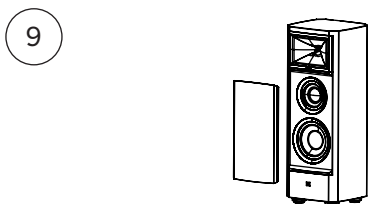
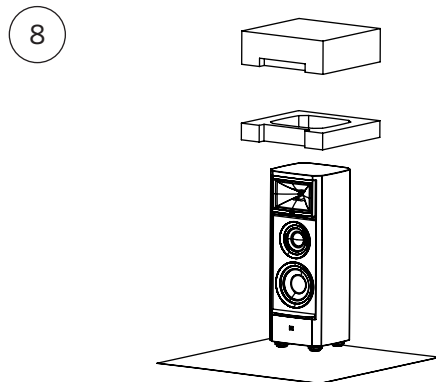
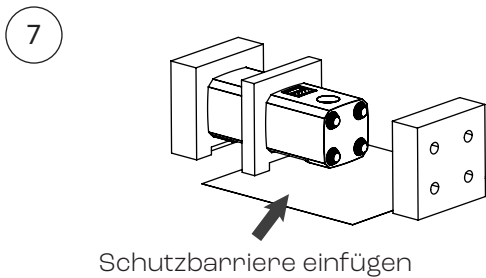
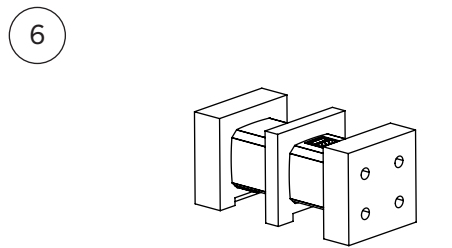
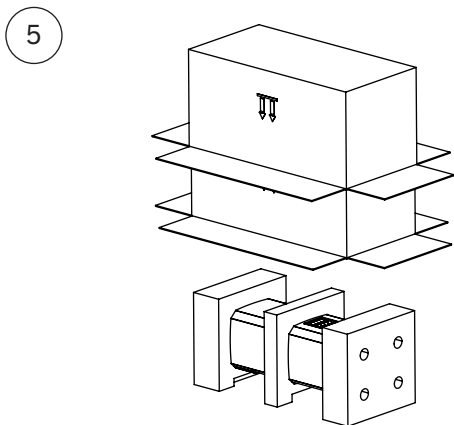
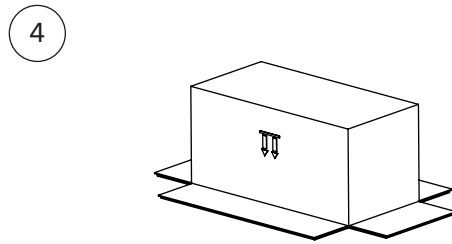
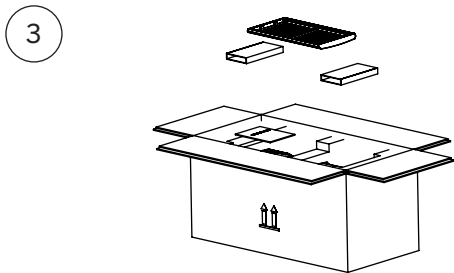
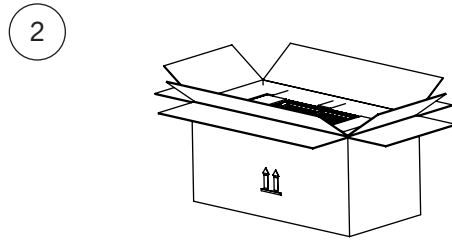
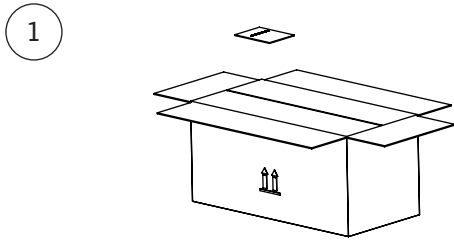

## Summit Ama Auspacken und Einrichten

1

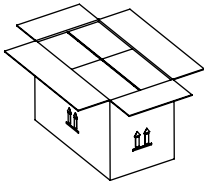

2

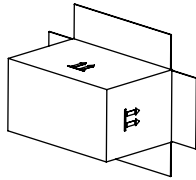

3

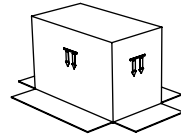

4

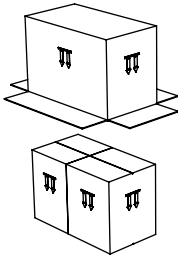

5

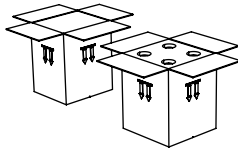

6

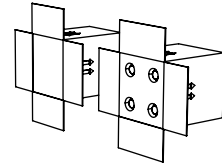

7

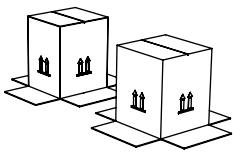

8

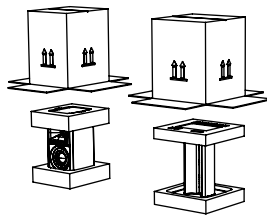

9

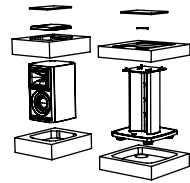

10

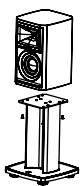

11

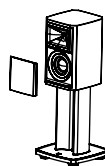

12

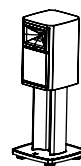

### Sockelmontage – Summit Ama

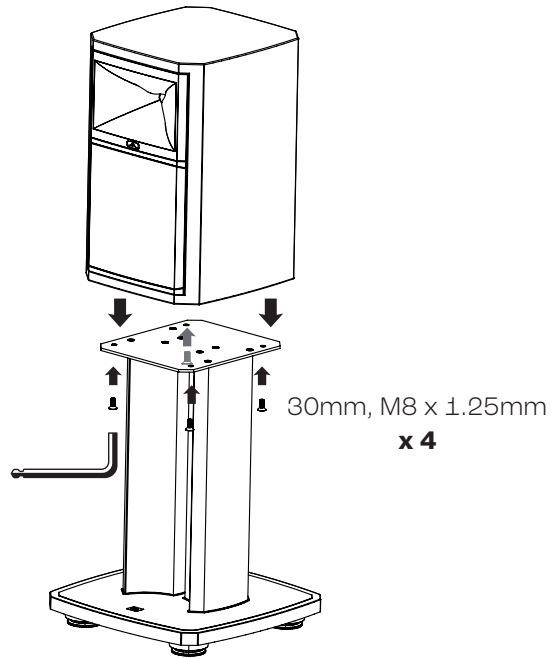

### Layout

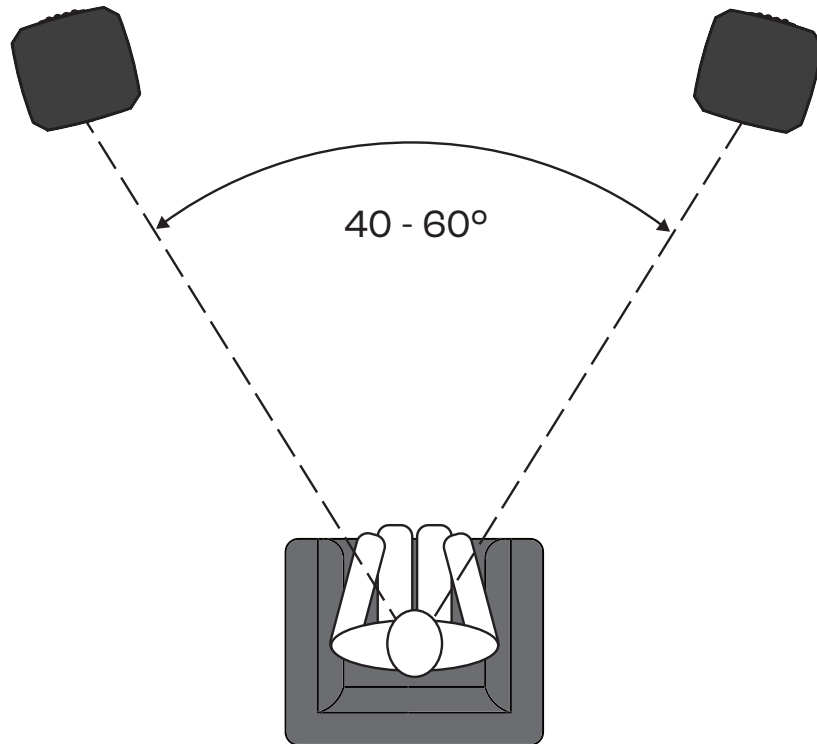

## Konfiguration und Verbindungen

### 1-Ader-Modus

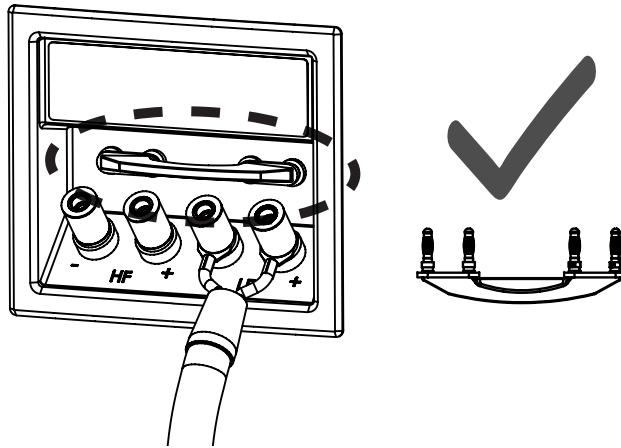

### 2-Ader/Doppel-Verstärker

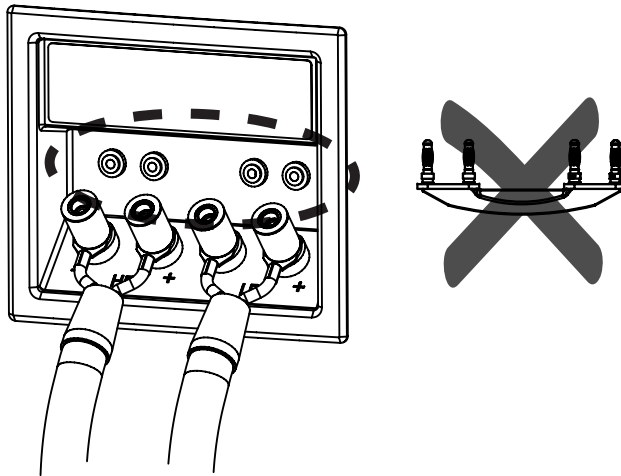

### Summit Ama Kabelmanagement

1

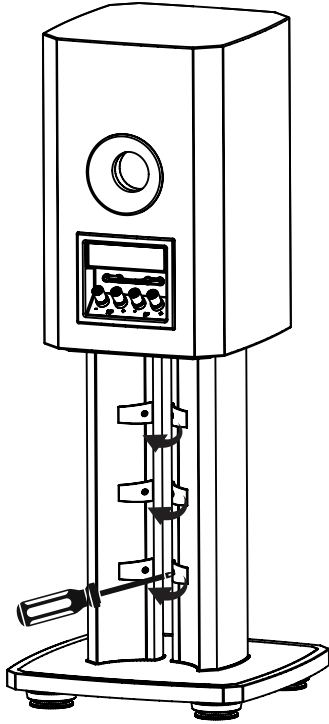

2

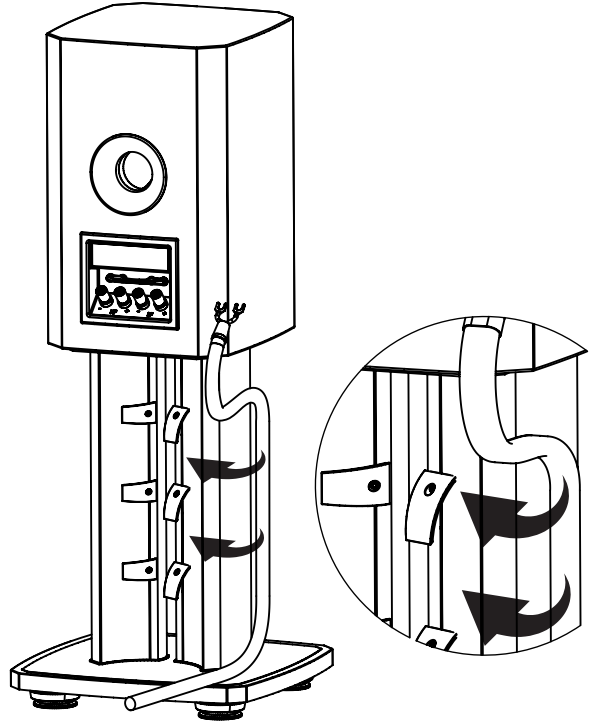

3

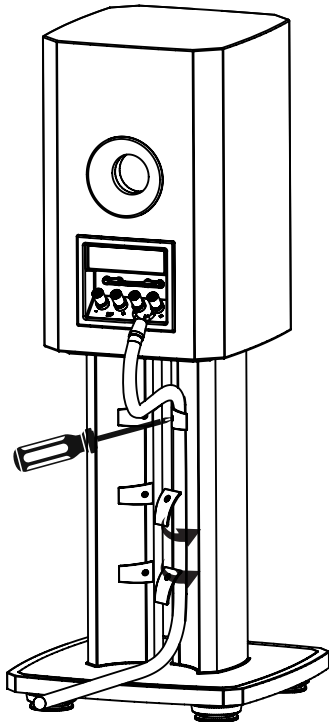

4

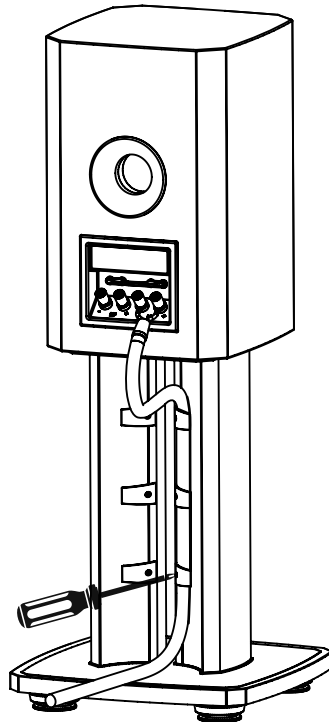

## Lautsprechereinstellung mit IsoAcoustics®-Füßen

Fuß ausfahren



Fuß einziehen



[www.isoacoustics.com](http://www.isoacoustics.com)



## Pflegehinweise

- ⌚ Übermäßige Hitze, Sonnenlicht und/oder Feuchtigkeit können zu Schäden am Produkt führen.
- ⌚ Das Äußere regelmäßig mit einem weichen Mikrofasertuch reinigen.
- ⌚ Die Verwendung von scharfen Chemikalien oder übermäßiger Feuchtigkeit bei der Reinigung ist zu vermeiden.
- ⌚ Das Gitter bitte vor der Reinigung vom Lautsprecher entfernen. Als Nächstes vorsichtig mit einem Staubsauger mit weichem Bürstenaufsatz Staub und Verunreinigungen absaugen.
- ⌚ Niemals flüssige Reinigungsmittel für die Schallgeber verwenden.
- ⌚ Niemals Druckluft für einen der Schallgeber verwenden, insbesondere für den Kompressionstreiber.
- ⌚ Bei Fragen wenden Sie sich bitte an unser Kundendienst-Team.

## Boas-vindas ao Summit

Agradecemos por escolher um sistema de caixas de som JBL da Summit Series. Estas caixas de som representam o resultado de nossos esforços de pesquisa e desenvolvimento em reprodução sonora ao longo dos últimos 80 anos. Acreditamos que a Série Summit é o que há de mais avançado que a tecnologia atual pode oferecer, criada para proporcionar uma experiência sonora sem limitações acústicas ou elétricas.

Este Guia de Início Rápido fornece as informações essenciais e as instruções necessárias para desembalar e configurar corretamente as suas caixas de som JBL da Summit Series. Os modelos abordados neste guia são os de chão Summit Makalu e Summit Pumori, e o modelo de estante Summit Ama. Neste guia, você encontrará recomendações gerais de segurança, orientações para desembalar, posicionamento no ambiente, conexões com eletrônicos, nivelamento, cuidados gerais e limpeza.

Para conhecer melhor as características técnicas das caixas de som da Série Summit, acesse a página do seu modelo em [www.jblsummit.com](http://www.jblsummit.com) ou fale com a nossa equipe de Apoio ao Cliente: nas Américas pelo telefone +1-888-691-4171 ou internacionalmente pelo telefone +44-1707-668-012.

[www.jblsummit.com](http://www.jblsummit.com)



## Notas de segurança

- ☞ Todas as caixas de som JBL da série Summit são equipamentos pesados. NÃO tente levantar ou mover a caixa de som sem assistência adequada. O peso desses modelos embalados excede o recomendado para uma pessoa levantar sozinha. Para evitar acidentes ou danos à caixa de som, são necessárias pelo menos duas pessoas para levantar ou mover o aparelho.
- ☞ Certifique-se de que as caixas de som JBL Summit estejam posicionadas sobre um piso firme e que os pés de apoio JBL | IsoAcoustic<sup>®</sup> estejam devidamente ajustados/nivelados na posição final no ambiente.
- ☞ NÃO APERTE excessivamente os parafusos ou terminais rosqueados da caixa de som.
- ☞ Antes de conectar qualquer componente elétrico às caixas de som, certifique-se de que estejam DESLIGADOS e desconectados das tomadas.
- ☞ Ao ligar os equipamentos conectados às caixas de som, verifique se o volume está ajustado para um nível baixo e aumente gradualmente para evitar danos.
- ☞ Se tiver dúvidas sobre como proceder com segurança, procure orientação profissional.

## Conteúdo da embalagem

### Summit Makalu

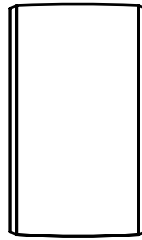

### Summit Pumori

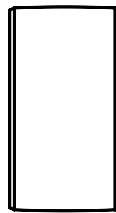

### Summit Ama

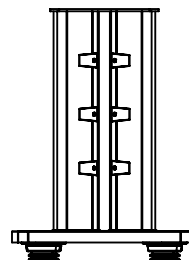
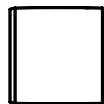

### Summit Makalu e Summit Pumori Desembalagem e instalação

1

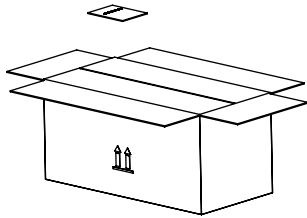

2

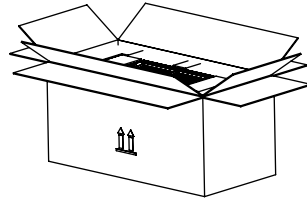

3

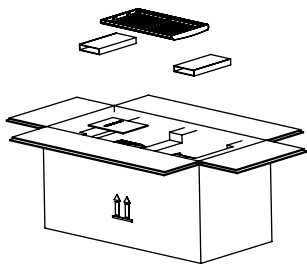

4

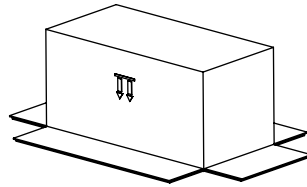

5

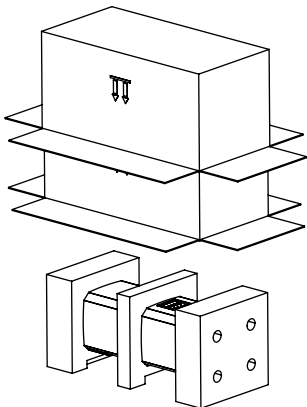

6

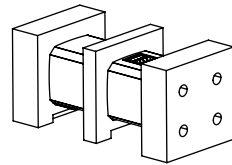

7

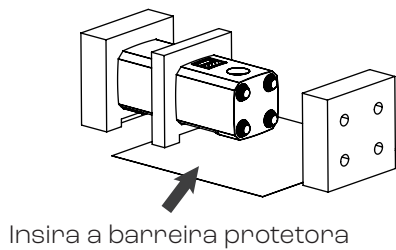

8

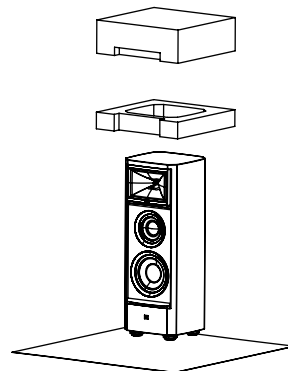

9

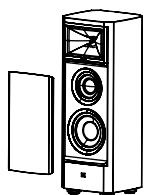

10

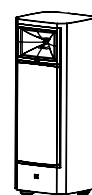

3

## Summit Ama Desembalagem e instalação

1

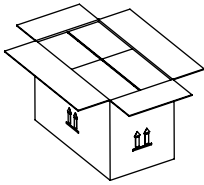

2

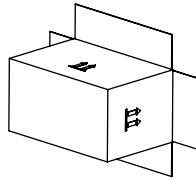

3

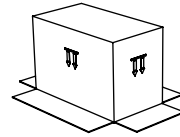

4

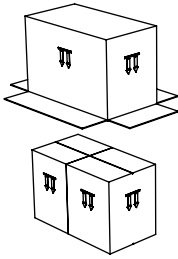

5

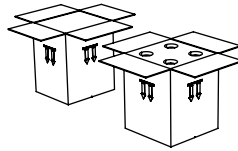

6

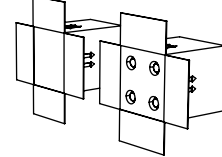

7

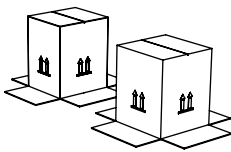

8

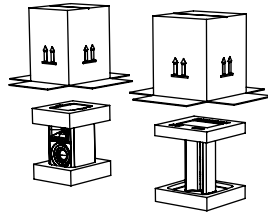

9

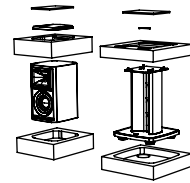

10

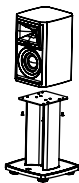

11

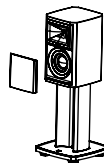

12

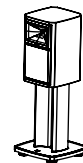

### Instalação do pedestal da Summit Ama

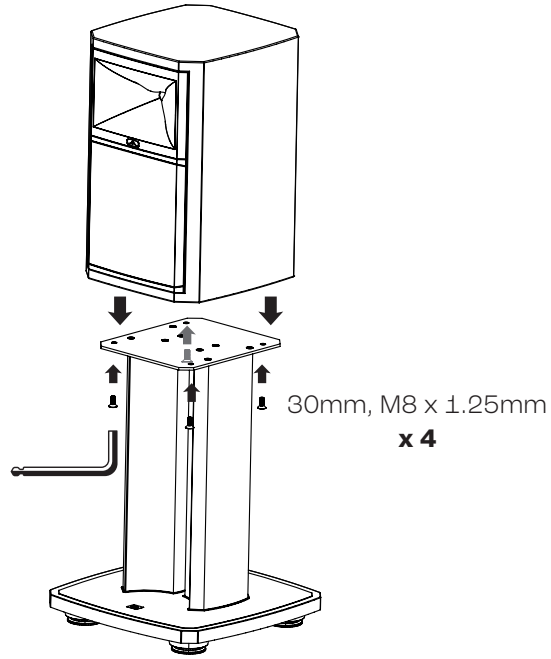

### Layout

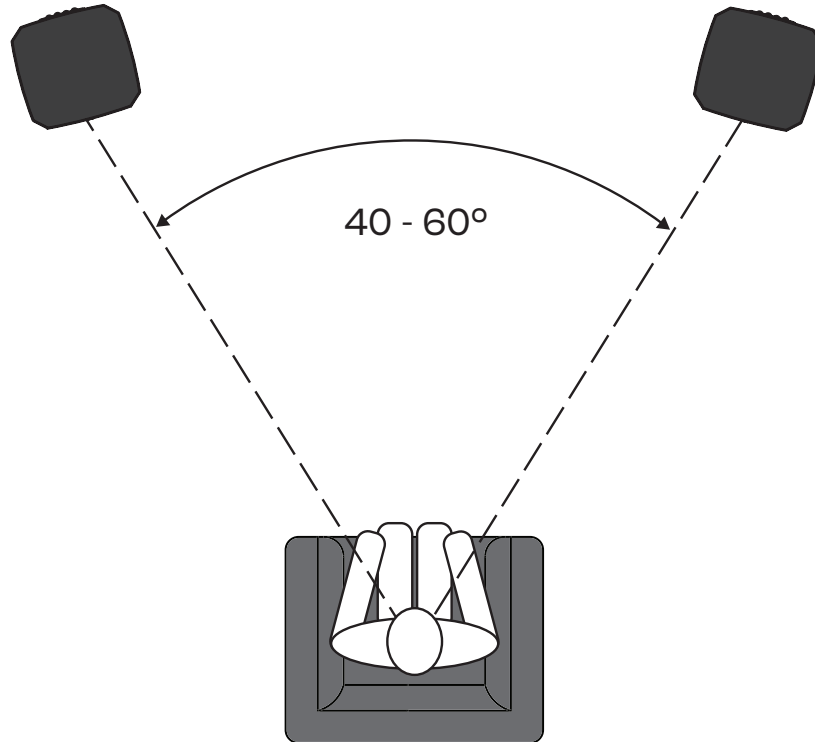

## Configuração e conexões

### Terminação simples

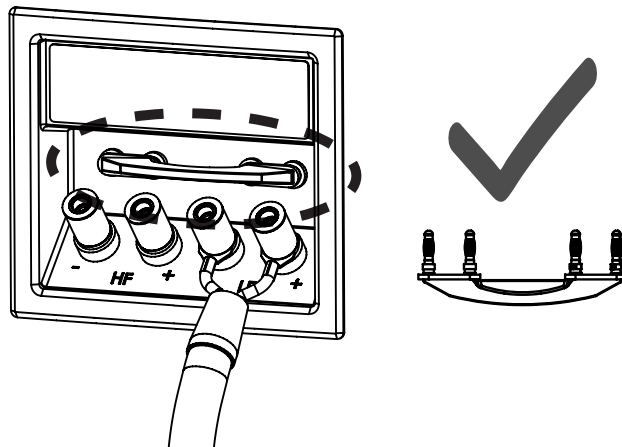

### Terminação com dois pares de fios/Bi-amplificada

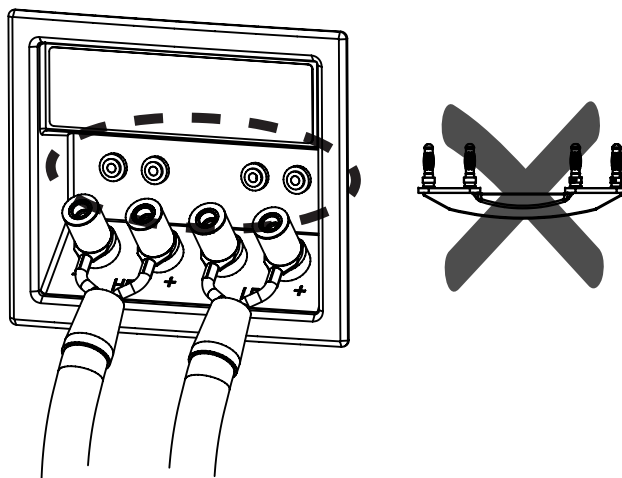

### Summit Ama Gerenciamento de cabos

1

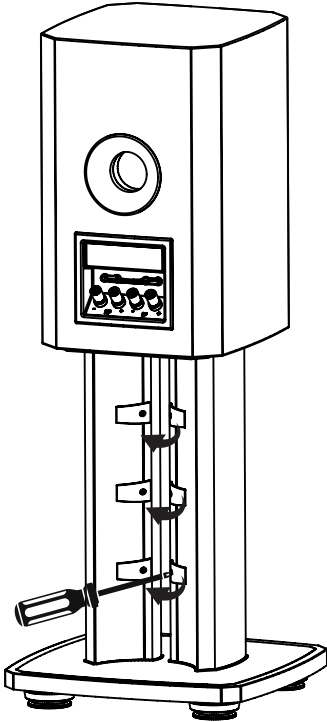

2

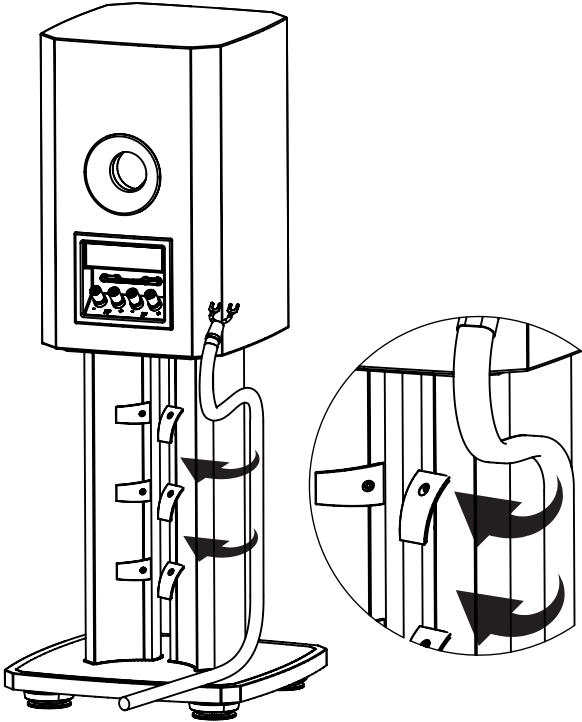

3

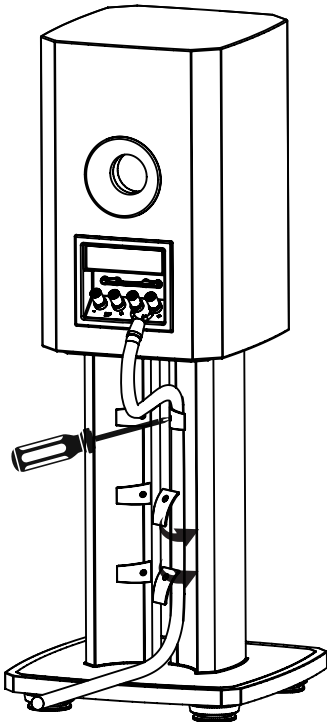

4

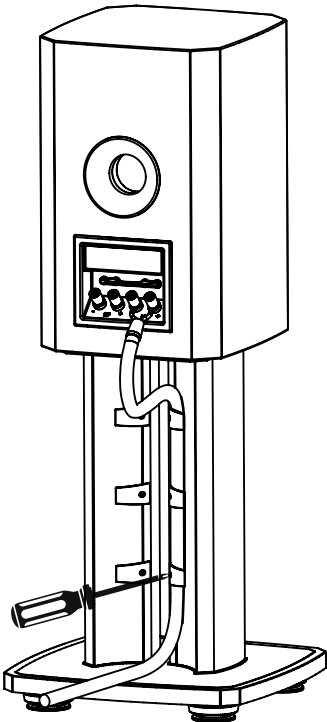

## Nivelamento da caixa de som usando pés de apoio IsoAcoustics®

Para alongar o pé de apoio



Para retrainir o pé de apoio



[www.isoacoustics.com](http://www.isoacoustics.com)



## Cuidados e manutenção

- º Calor excessivo, luz solar direta e/ou umidade podem danificar o produto.
- º Limpe regularmente a parte externa com um pano de microfibra macio.
- º Evite o uso de produtos químicos agressivos ou umidade excessiva durante a limpeza.
- º Para limpar a grade, remova-a primeiro da caixa de som. Em seguida, utilize cuidadosamente um aspirador com escova macia para retirar poeira e resíduos.
- º Nunca use produtos líquidos nos transdutores.
- º Nunca use ar comprimido em nenhum dos transdutores, especialmente no driver de compressão.
- º Em caso de dúvida, entre em contato com a nossa equipe de Apoio ao Cliente.

## Summit에 오신 것을 환영합니다

JBL Summit 시리즈 스피커 시스템을 선택해 주셔서 감사합니다. 이 스피커들은 지난 80년간 음향 재생에 대한 연구 개발의 결실입니다. 우리는 Summit 시리즈가 현재의 기술로 만들 수 있는 최상의 스피커 라인업이라고 믿으며, 음향적 또는 전기적인 한계가 없는 스피커 시스템을 만드는 것을 목표로 하고 있습니다.

이 빠른 시작 가이드에는 JBL Summit 시리즈 스피커 포장을 안전하게 풀고 설치하기 위한 필수 배경 지식과 지침이 포함되어 있습니다. 이 가이드에 포함된 모델은 바닥 스탠딩형 Summit Makalu와 Summit Pumori, 스탠드 장착형 Summit Ama입니다. 이 가이드는 일반적인 안전 조치, 개봉, 실내 배치, 관련 전자기기와의 연결, 수평 조정, 일반적인 관리 및 세척 방법 등을 설명합니다.

JBL Summit 시리즈 스피커에 적용된 특별한 디자인과 기술적 특징을 더 깊이 알아보고 싶으시다면, [www.jblsummit.com](http://www.jblsummit.com)에서 해당 모델의 제품 페이지를 방문하시거나, 미주 지역 고객 지원팀(+1-888-691-4171) 또는 국제 고객 지원팀(+44-1707-668-012)으로 문의해 주시기 바랍니다.

[www.jblsummit.com](http://www.jblsummit.com)



## 안전 지침

- ⦿ 모든 JBL Summit 시리즈 스피커는 상당한 무게를 가지고 있습니다. 충분한 도움 없이 스피커를 들어 올리거나 이동하려 하지 마십시오. 이 모델들의 배송 무게는 사람 1명이 혼자서 들 수 있는 무게를 초과합니다. 부상 또는 스피커 손상을 방지하려면 스피커를 들거나 움직일 때 최소 2명이 필요합니다.
- ⦿ JBL Summit 시리즈 스피커는 반드시 견고한 바닥 위에 설치해 주시고, 스피커를 최종 위치에 배치한 후에는 JBL | IsoAcoustic® 받침대가 적절히 조정되고 수평이 맞춰져 있는지 확인해 주십시오.
- ⦿ 나사나 스피커 바인딩 포스트를 과도하게 조이지 마십시오.
- ⦿ 스피커에 연결될 모든 전기 구성 요소는 반드시 전원이 꺼져 있고, 콘센트에서 분리되어 있어야 합니다.
- ⦿ 스피커에 연결된 전자기기의 전원을 켤 때는, 볼륨이 낮게 설정되어 있는지 반드시 확인한 후, 천천히 볼륨을 높여서 잠재적인 손상을 방지하십시오.
- ⦿ 안전한 절차에 확신이 없는 경우, 전문가의 도움을 받으시기 바랍니다.

패키지 구성품

Summit Makalu

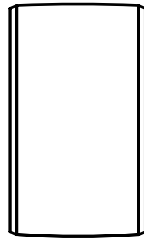

Summit Pumori

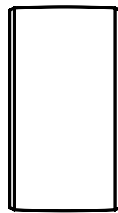

Summit Ama

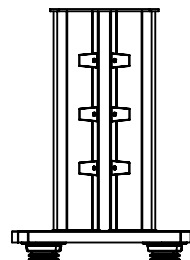
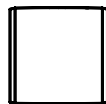

### Summit Makalu 및 Summit Pumori 개봉 & 설치

1

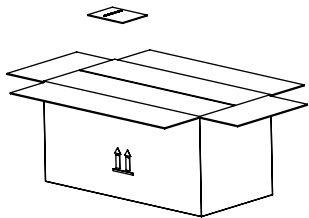

2

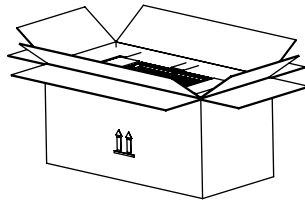

3

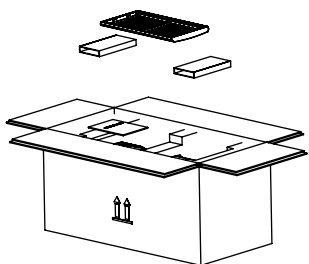

4

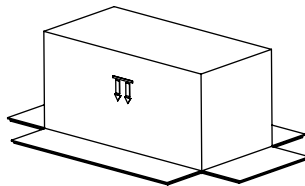

5

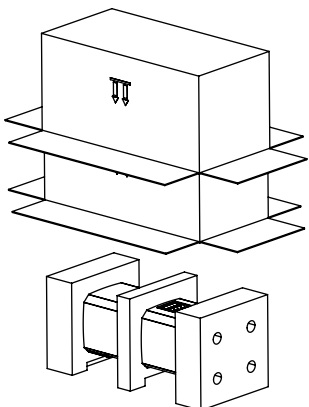

6

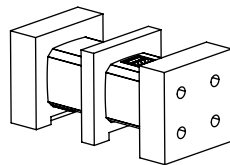

7

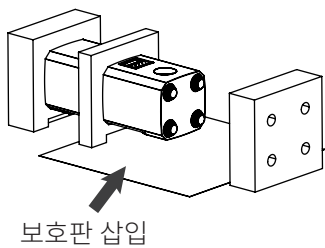

8

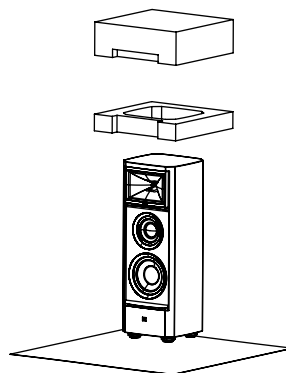

9

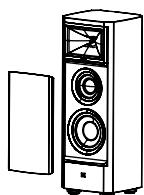

10

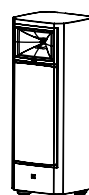

### Summit Ama 개봉 & 설치

1

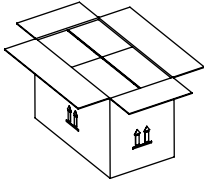

2

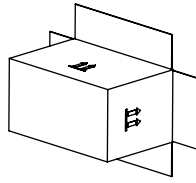

3

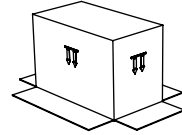

4

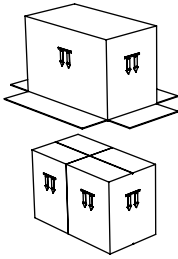

5

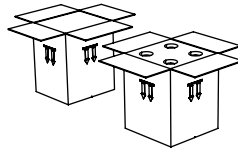

6

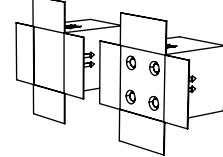

7

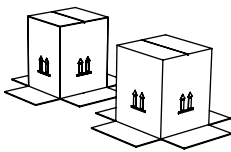

8

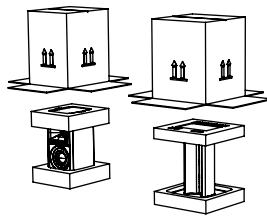

9

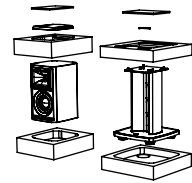

10

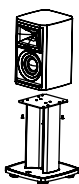

11

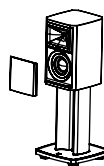

12

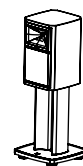

### Summit Ama 받침대 설치

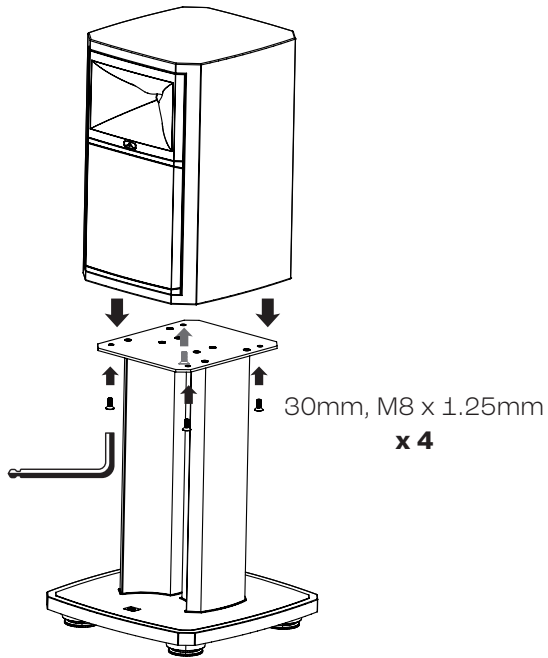

### 레이아웃

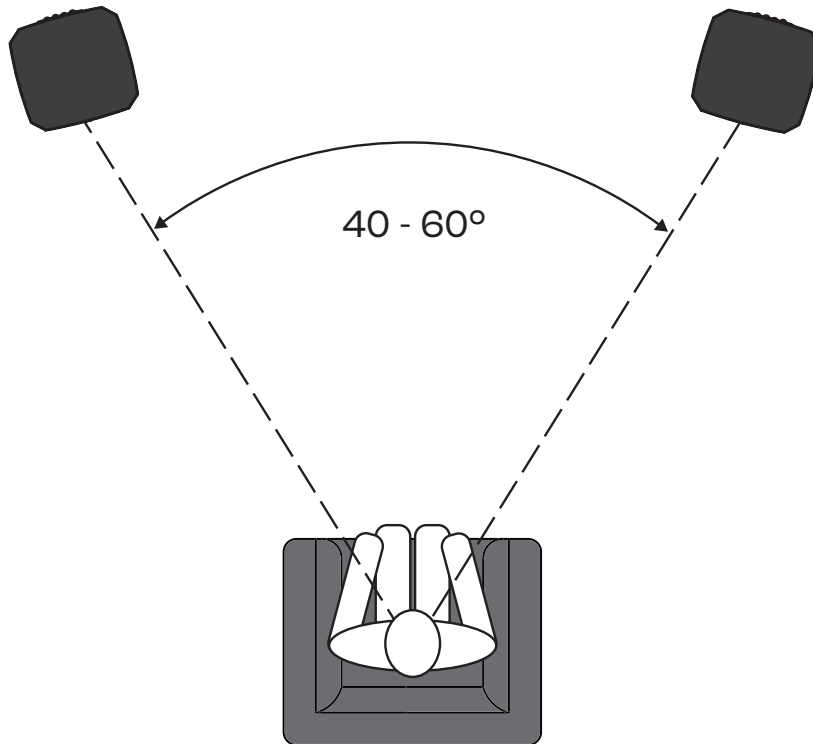

## 구성 & 연결

### 싱글 엔드

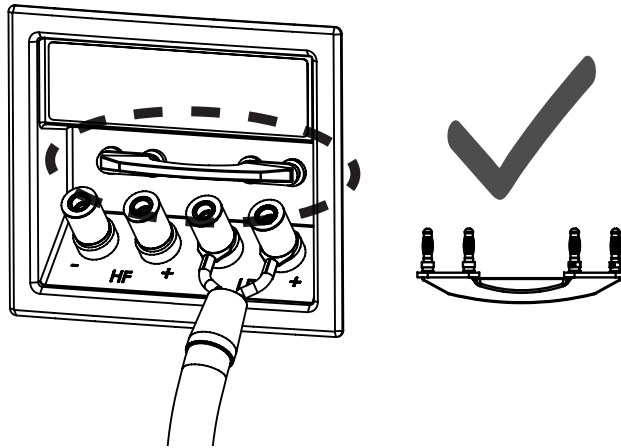

### 이중 배선 / 바이 앰프

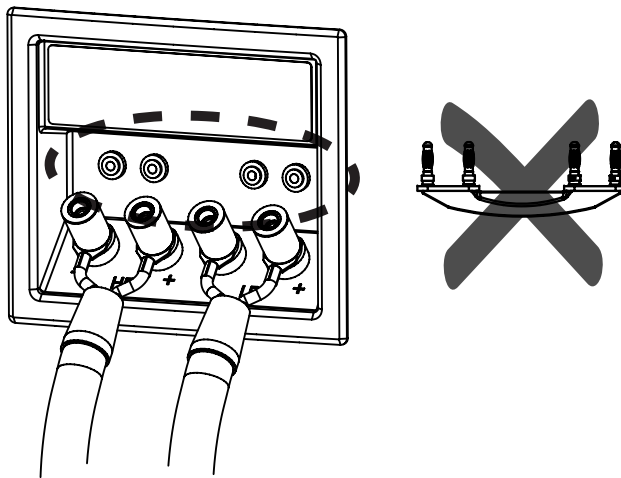

### Summit Ama 케이블 관리

1

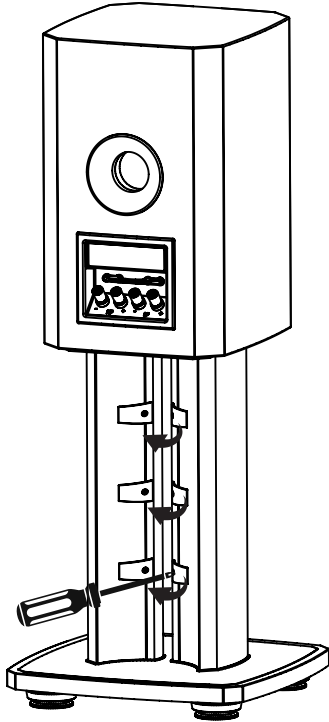

2

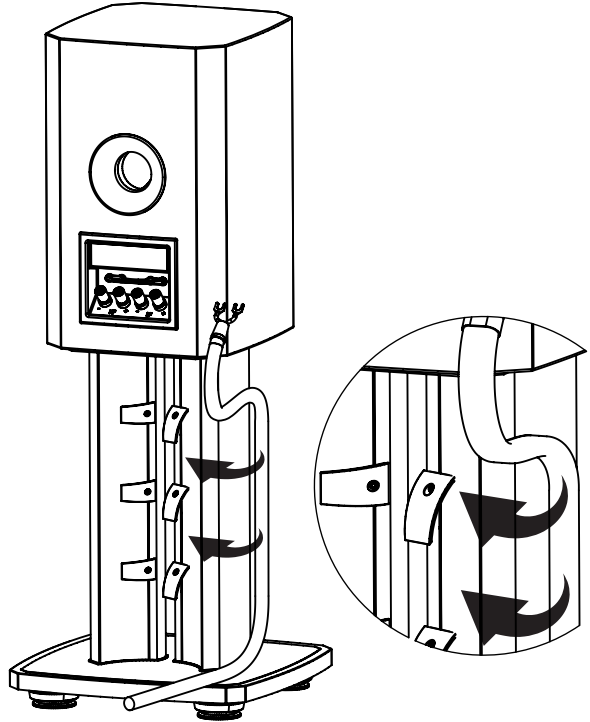

3

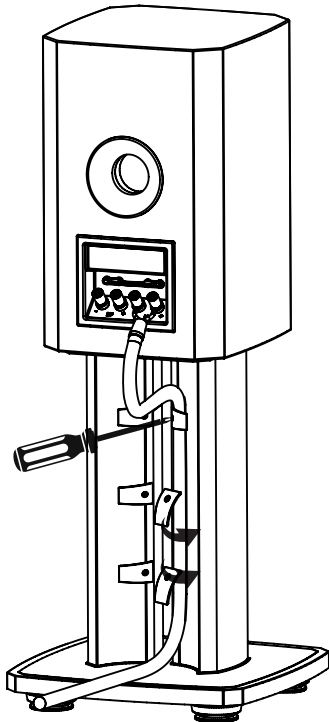

4

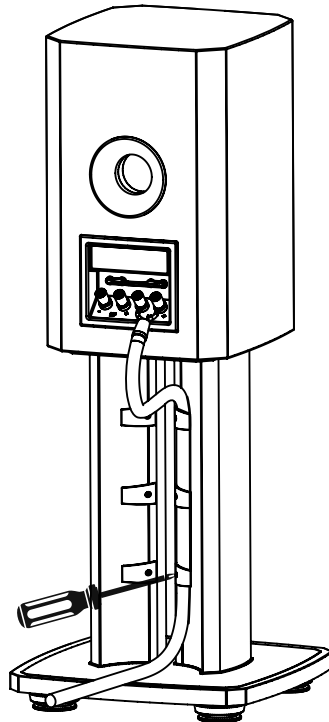

## IsoAcoustics® 받침대를 이용한 스피커 수평 조절

다리 확장 방법



다리 수축 방법



[www.isoacoustics.com](http://www.isoacoustics.com)



## 취급 지침

- 과도한 열, 햇빛 및 습기는 제품 손상의 원인이 될 수 있습니다.
- 외부는 부드러운 극세사 천으로 정기적으로 닦아 주십시오.
- 세척 시 강한 화학 약품이나 과도한 수분 사용은 피하십시오.
- 그릴을 청소하려면 먼저 스피커에서 그릴을 분리하십시오. 그런 다음 부드러운 브러시가 부착된 진공 청소기를 사용하여 먼지와 이물질을 조심스럽게 제거하십시오.
- 변환기에는 절대 액체 세제를 사용하지 마십시오.
- 특히 압축 드라이버를 포함한 변환기에는 절대 압축 공기를 사용하지 마십시오.
- 확실하지 않은 경우, 고객 지원팀에 문의해 주십시오.



## Summitへようこそ

JBL Summitシリーズのスピーカーシステムをお選びいただき、ありがとうございます。これらのスピーカーは、80年にわたる私たちの音響再生に関する研究開発の集大成です。Summitシリーズは、現在の技術で構築可能な最高のスピーカーファミリーであり、音響的・電氣的な制約から解放されたスピーカーシステムを目指して開発されたものだと私たちは信じています。

このクイックスタートガイドには、JBL Summitシリーズスピーカーを安全に開梱・設置するために必要な情報と指示が記載されています。本ガイドに記載されているモデルは、フロアスタンディング型のSummit MakaluとSummit Pumori、そしてスタンドマウント型のSummit Amaです。本ガイドでは一般的な安全上の注意、開梱方法、室内での設置位置、接続機器との接続、水平確認、そして日常的なお手入れと掃除について説明します。

JBL Summitシリーズスピーカーに採用された独自の設計や技術的特徴についてさらに深くご理解いただくために、それぞれのモデルの製品ページ、[www.jblsummit.com](http://www.jblsummit.com)にアクセスいただくか、または+1-888-691-4171（米国）または+44-1707-668-012（国際電話）のカスタマーサポートまでお問い合わせください。

[www.jblsummit.com](http://www.jblsummit.com)



## 安全上の注意

- ⦿ JBL Summitシリーズスピーカーは、どのモデルも相当な重量があります。適切なサポートなしに、決してスピーカーを持ち上げたり移動させたりしようとししないでください。これらのモデルの梱包重量は、一人で持ち上げられる重量を超えています。怪我またはスピーカーの損傷を避けるため、スピーカーを持ち上げたり、動かしたりする際には少なくとも二人以上で行ってください。
- ⦿ JBL Summitシリーズスピーカーはしっかりとした床の上に設置し、設置後はJBL | IsoAcoustic<sup>®</sup>フットが適切に調整され、水平になっていることをお確かめください。
- ⦿ 絶対にねじまたはスピーカー端子をきつく締めすぎないでください。
- ⦿ スピーカーを接続する前に、スピーカーに接続するすべての電気製品の電源が切れていて、コンセントからプラグが抜いてあることをお確かめください。
- ⦿ スピーカーに接続された電気機器の電源を入れる場合は、音量が低く設定されていることを確認し、スピーカーの損傷を避けるために、音量をゆっくりと上げてください。
- ⦿ 安全な手順が不明な場合は、専門家に相談してください。

## パッケージの中身

### Summit Makalu

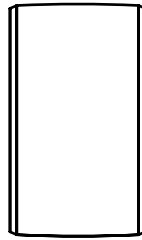

### Summit Pumori

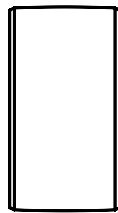

### Summit Ama

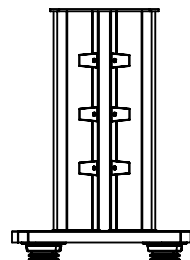
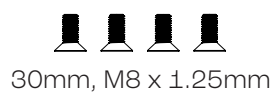
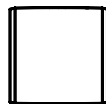

Summit MakaluとSummit Pumori 開梱と設置

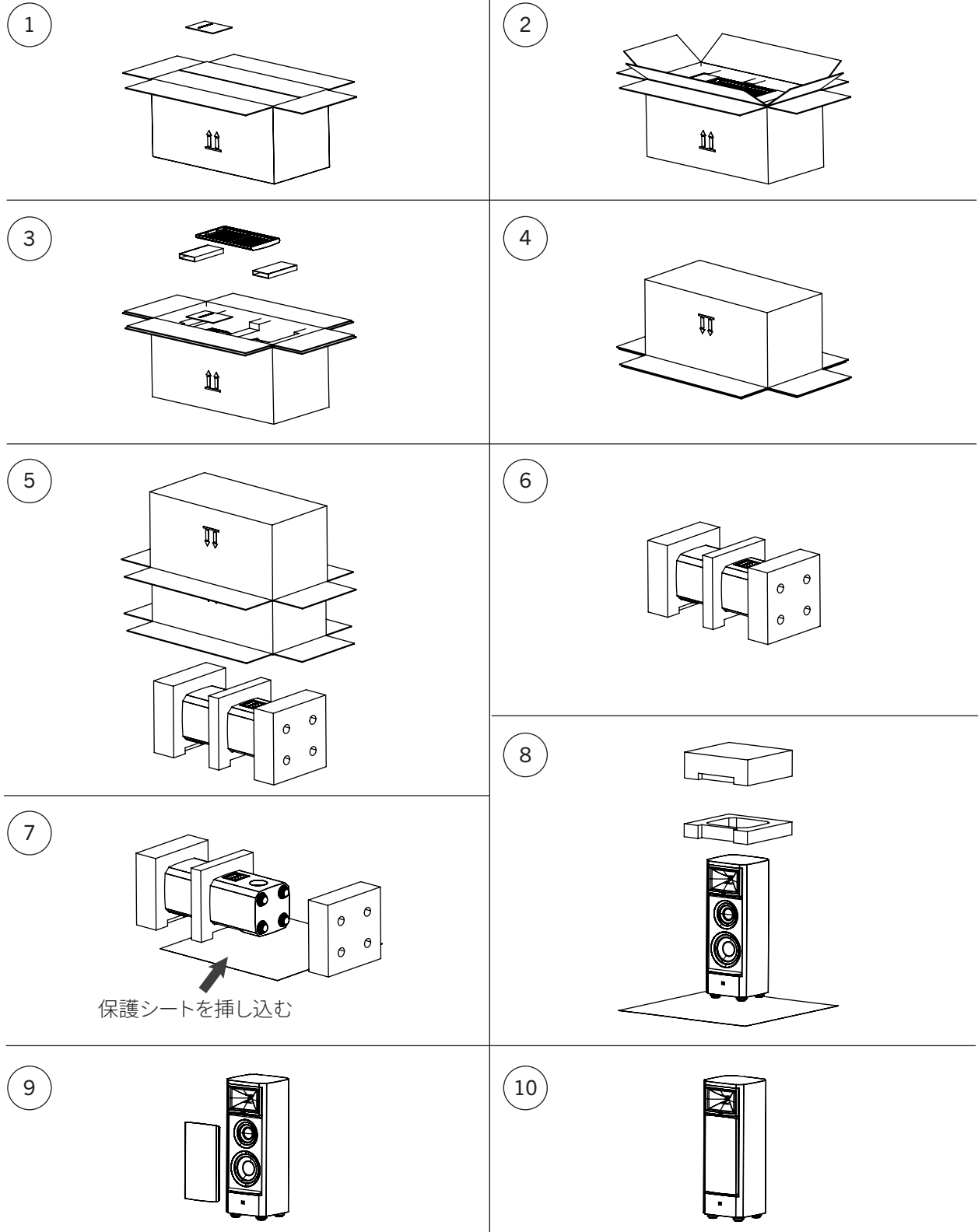

## Summit Ama 開梱と設置

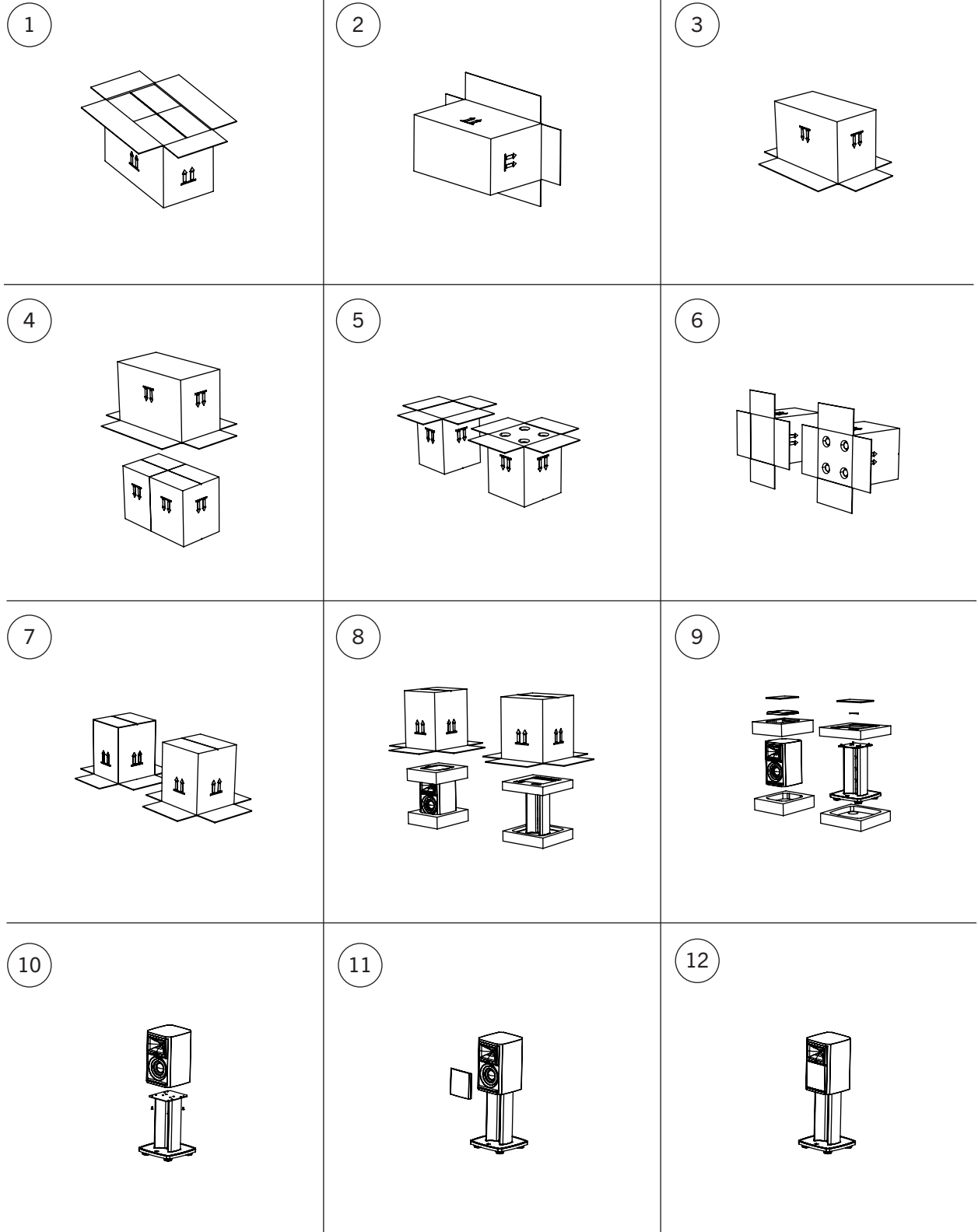

### Summit Amaスタンドへの取り付け

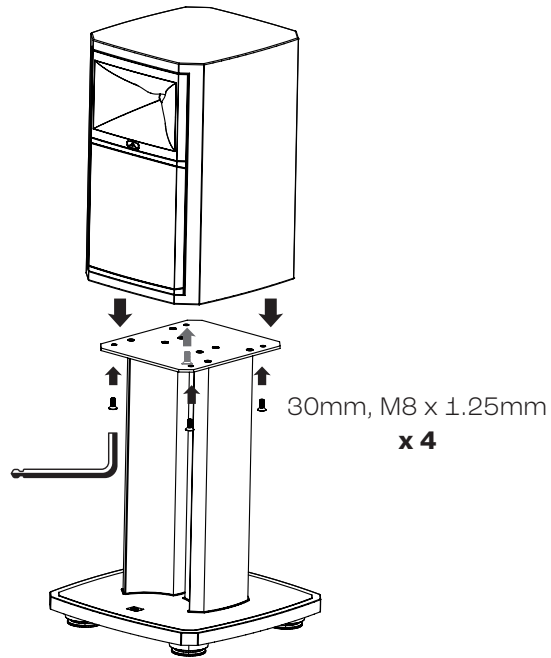

### レイアウト

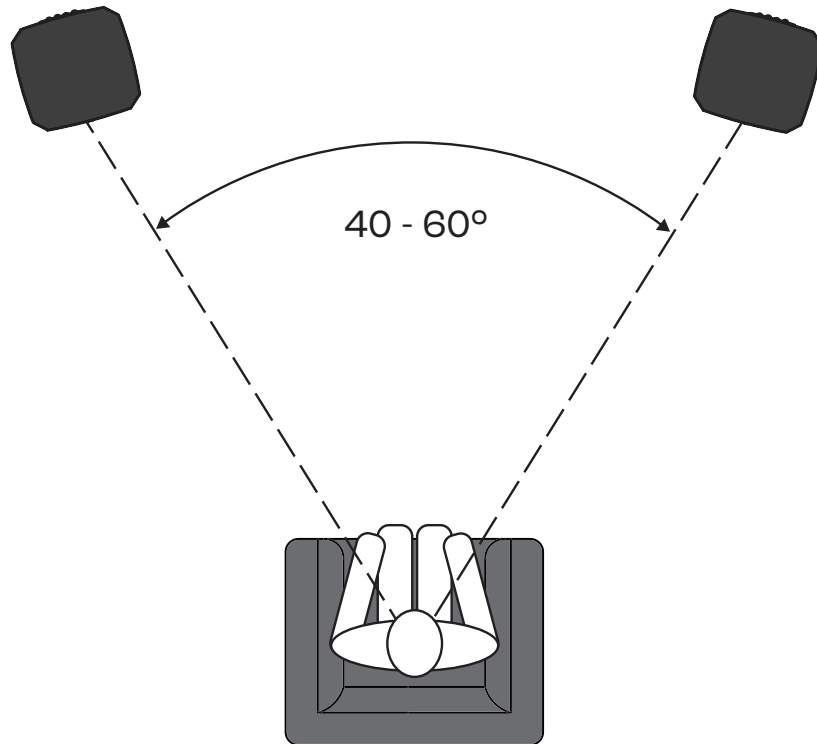

## 設定と接続

### シングルエンド

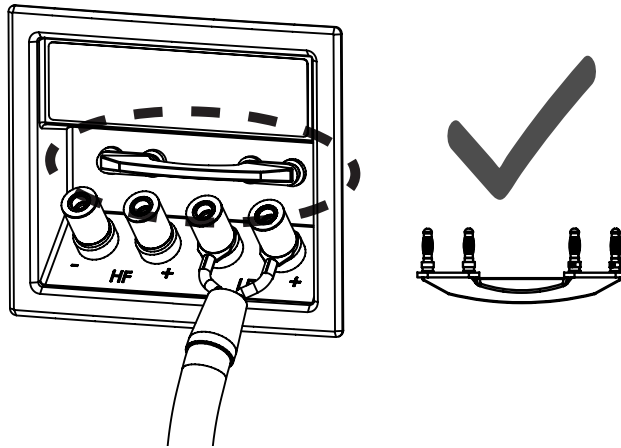

### バイワイヤー/バイアンプ

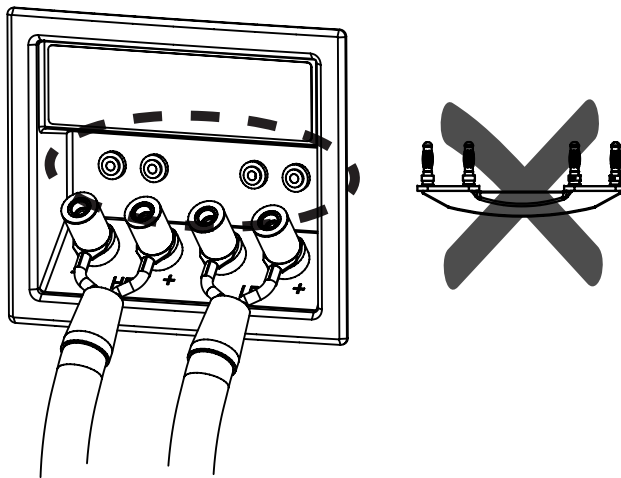

### Summit Ama ケーブルマネージメント

1

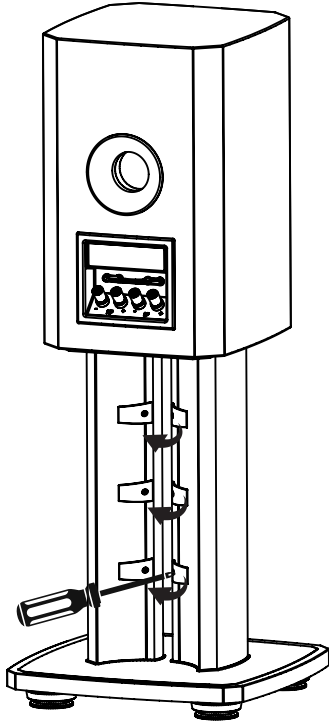

2

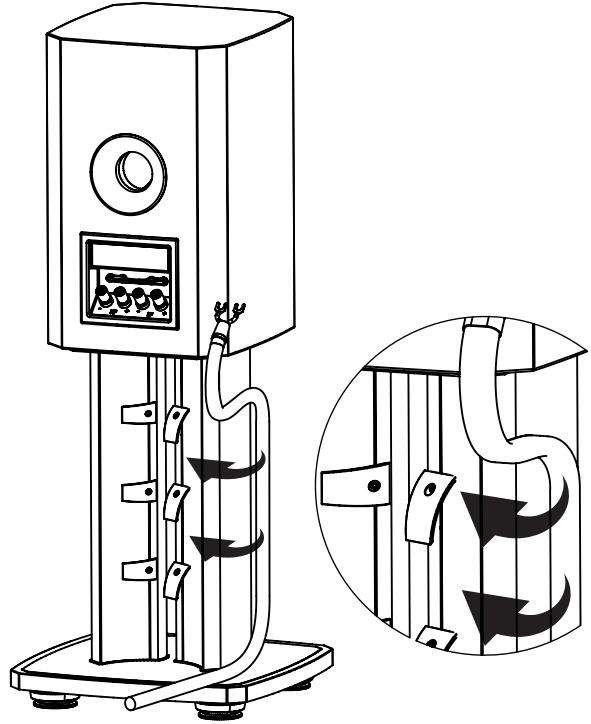

3

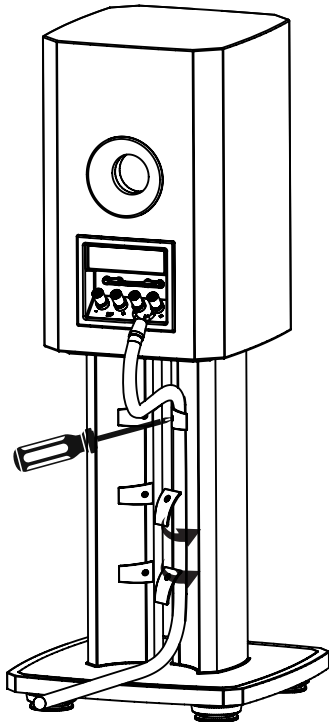

4

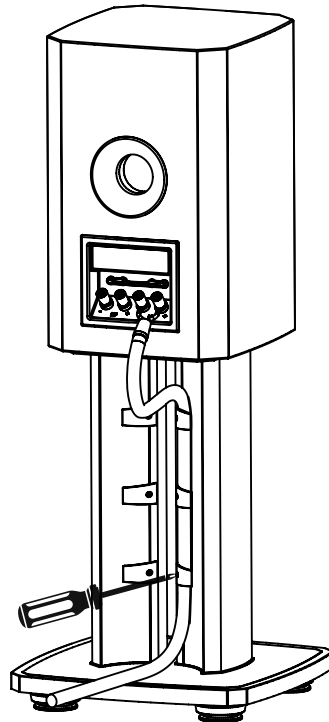

## IsoAcoustics®フットを使用したスピーカーの水平調整

フットを延ばすには



フットを縮めるには



[www.isoacoustics.com](http://www.isoacoustics.com)



## お手入れ方法

- 過度の熱、日光および湿気は製品の損傷につながる可能性がありますのでご注意ください。
- 外装は、定期的に柔らかいマイクロファイバークロスで拭いてください。
- 強い化学薬品や過度の水分を使用する清掃は避けてください。
- グリルを掃除するには、まずスピーカーから取り外してください。次に、柔らかいブラシを取り付けた掃除機でほこりやゴミを丁寧に吸い取ってください。
- ドライバーには液体クリーナーを絶対に使用しないでください。
- ドライバー、特にコンプレッションドライバーには圧縮空気を絶対に使用しないでください。
- 不明な点がある場合は、カスタマーサポートにお問い合わせください。



## 欢迎使用 Summit

感谢你选择 JBL Summit Series 扬声器系统。这些扬声器凝聚了我们 80 年来在声音重现方面的研发成果。我们相信，Summit Series 是当前技术条件下能够打造的最出色的扬声器产品。我们旨在创建不受声学或电气限制的扬声器系统。

这本快速入门指南提供了安全拆箱和安装 JBL Summit Series 扬声器所需的背景信息与操作说明。本指南涵盖的型号包括落地式的 Summit Makalu 和 Summit Pumori，以及支架式的 Summit Ama。本指南将介绍一般安全注意事项、拆箱、室内摆放、与相关电子设备的连接、调平，以及日常护理与清洁方法。

为了更深入了解 JBL Summit Series 扬声器所采用的独特设计与技术特性，我们建议你访问 [www.jblsummit.com](http://www.jblsummit.com)，浏览相应型号的产品页面，或拨打 +1-888-691-4171（美洲）或 +44-1707-668-012（国际）联系客户支持团队。

[www.jblsummit.com](http://www.jblsummit.com)



## 安全注意事项

- ⦿ JBL Summit Series 的所有扬声器重量都较大。未获得足够帮助时，请勿尝试搬动或抬起扬声器。这些型号的运输重量超出了一人可单独搬运的范围。为避免人员受伤或扬声器损坏，搬运这些扬声器时至少需要两人协作。
- ⦿ 请务必将 JBL Summit Series 扬声器放置在坚固的地面上，并在扬声器安装定位后，正确调整并调平 JBL IsoAcoustic<sup>®</sup> 支脚。
- ⦿ 请勿过度拧紧螺钉或扬声器接线柱。
- ⦿ 在连接电气组件到扬声器之前，请确保所有将连接至扬声器的电气设备均已关闭，并已从电源插座中拔出。
- ⦿ 在为连接扬声器的电子设备通电前，请把音量调低，通电后再慢慢调高，以免损坏设备。
- ⦿ 如果你不确定如何安全操作，请寻求专业指导。

包装清单

Summit Makalu

快速入门指南

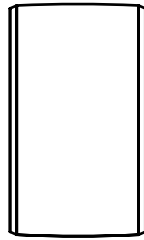

Summit Pumori

快速入门指南

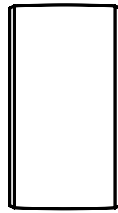

Summit Ama

快速入门指南

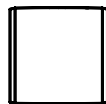

30mm, M8 x 1.25mm

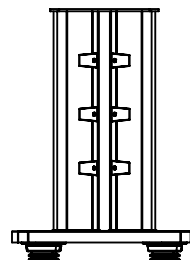

Summit Makalu 和 Summit Pumori 拆箱与安装

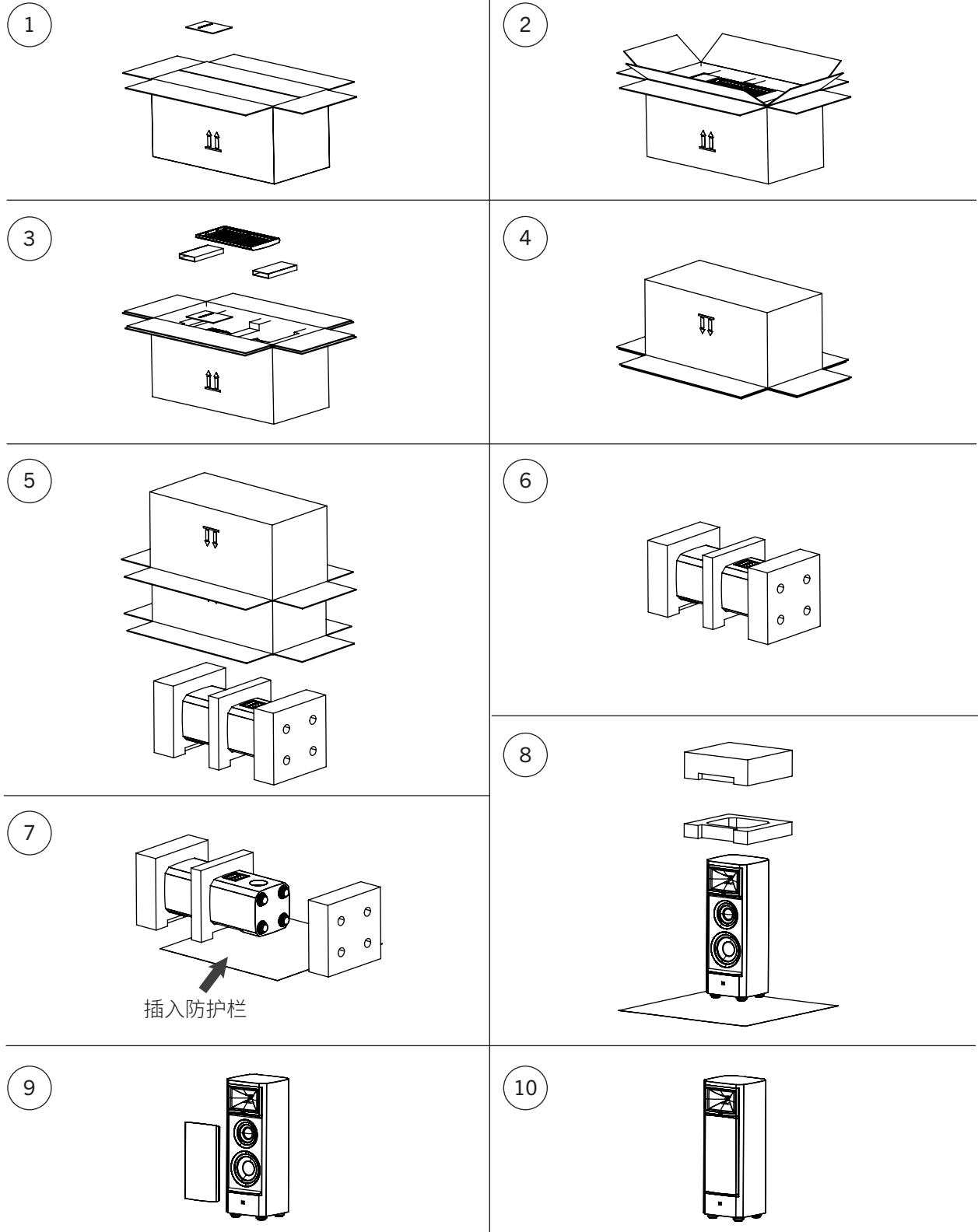

### Summit Ama 拆箱与安装

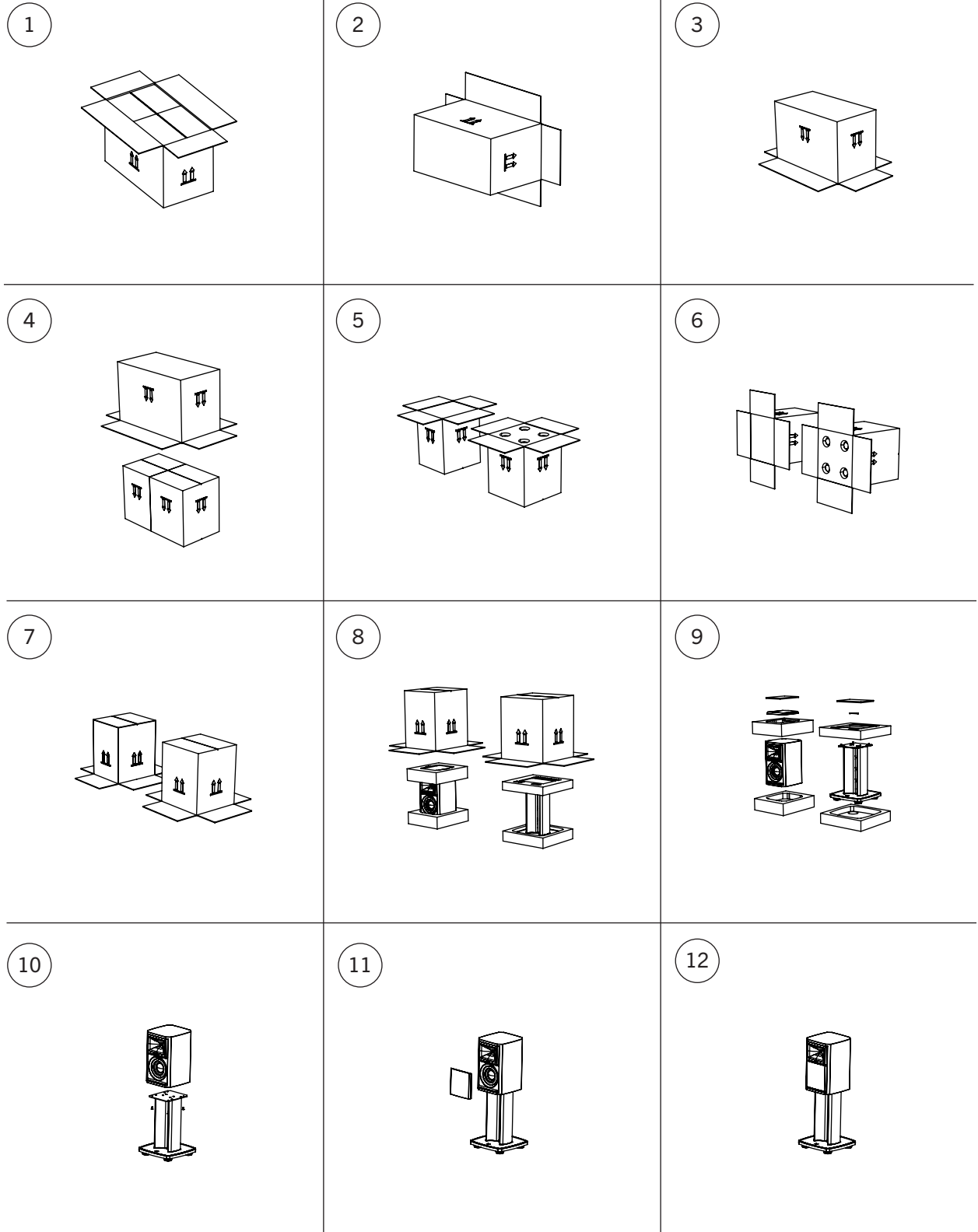

### Summit Ama 底座安装

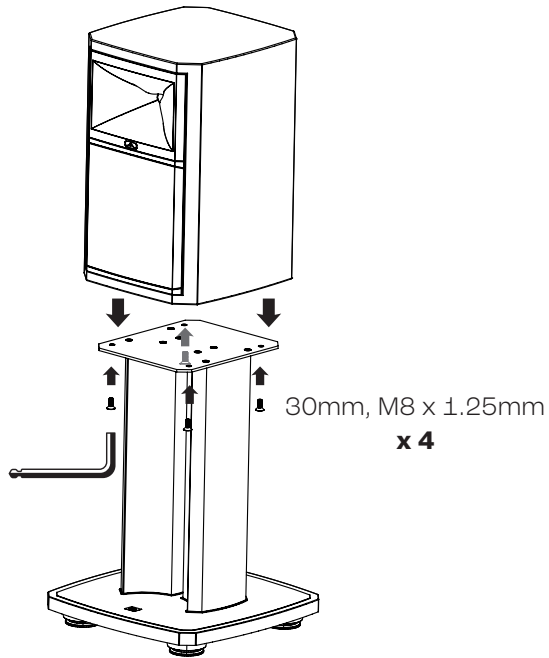

### 布局

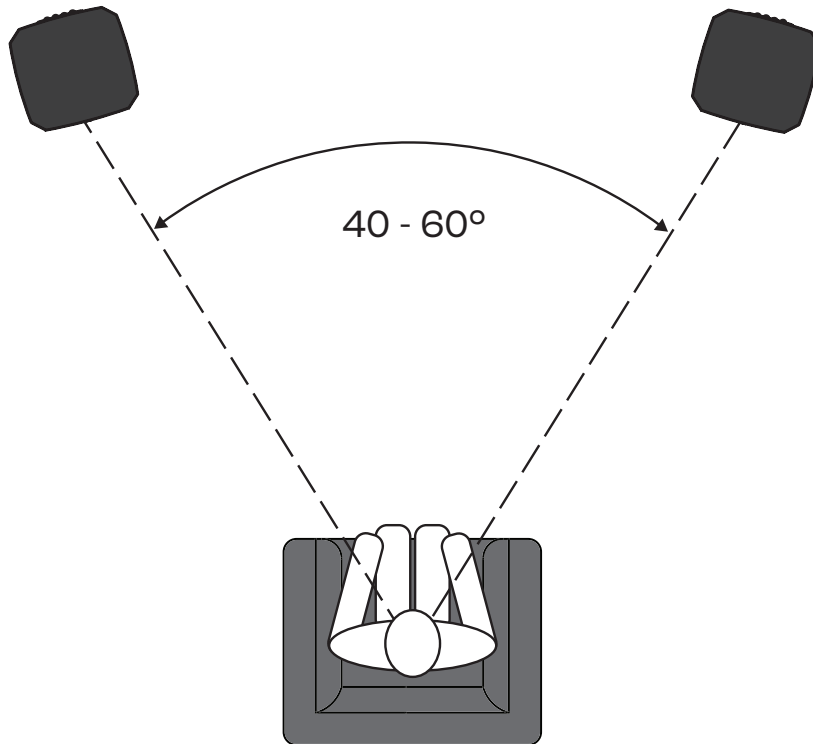

## 配置与连接

### 单端连接

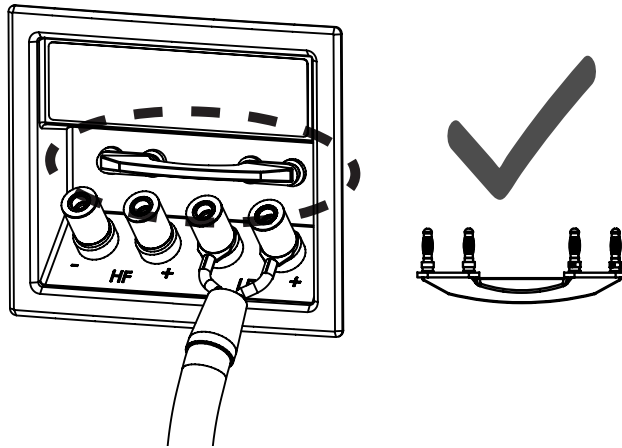

### 双线/双功放连接

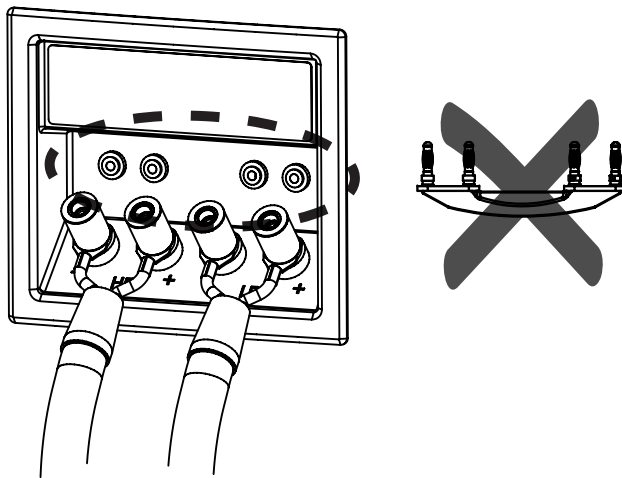

线缆整理 (Summit Ama)

1

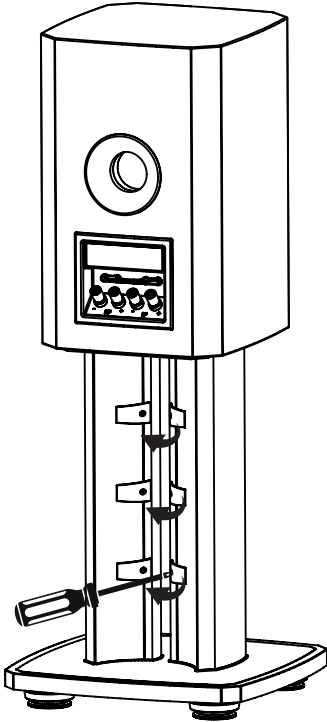

2

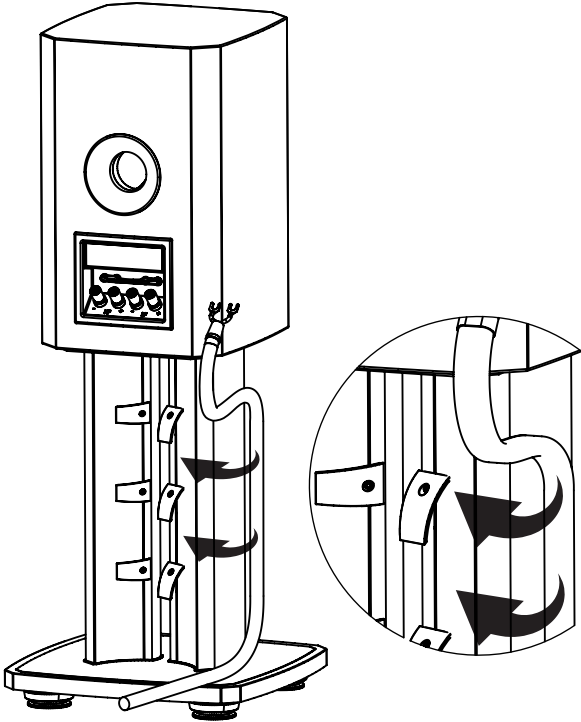

3

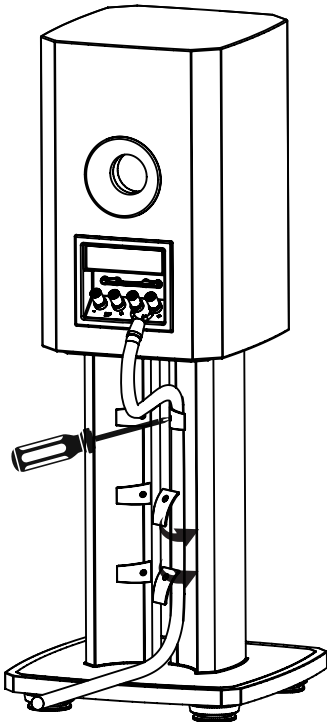

4

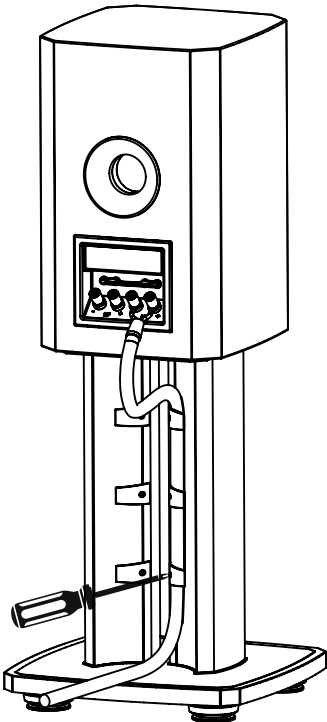

7

## 使用 IsoAcoustics® 支脚进行扬声器调平

伸出支脚



收回支脚



[www.isoacoustics.com](http://www.isoacoustics.com)



## 使用与保养说明

- ⦿ 高温、阳光暴晒和/或潮湿环境可能会损坏产品。
- ⦿ 请定期使用柔软的超细纤维布清洁产品外壳。
- ⦿ 清洁时避免使用刺激性化学品，避免过度潮湿。
- ⦿ 如需清洁格栅，请先将其从扬声器上取下。然后，小心使用带软刷附件的吸尘器清除灰尘和杂质。
- ⦿ 切勿在任何转换器上使用液体清洁剂。
- ⦿ 切勿在任何转换器上使用压缩空气，尤其是压缩驱动器。
- ⦿ 如有任何疑问，请联系客户支持团队寻求帮助。



This page intentionally left blank



产品中有害物质的名称及含有信息表

部件名称	有害物质									
	铅 (Pb)	汞 (Hg)	镉 (Cd)	六价铬 (Cr(VI))	多溴联苯 (PBBs)	多溴二苯醚 (PBDEs)	邻苯二甲酸二正丁酯 (DBP)	邻苯二甲酸二异丁酯 (DIBP)	邻苯二甲酸丁苄酯 (BBP)	邻苯二甲酸(2-乙基)己酯 (DEHP)
木箱	o	o	o	o	o	o	o	o	o	o
金属件	x	o	o	o	o	o	o	o	o	o
线路板及其组件	x	o	o	o	o	o	o	o	o	o
塑胶件	o	o	o	o	o	o	o	o	o	o
喇叭单元	x	o	o	o	o	o	o	o	o	o

注1: o:表示该有害物质在该部件所有均质材料中的含量均不超过电器电子产品有害物质限制使用国家标准要求。  
 x:表示该有害物质至少在该部件的某一均质材料中的含量超出电器电子产品有害物质限制使用国家标准要求。  
 注2: 以上未列出的部件,表明其有害物质含量均不超过电器电子产品有害物质限制使用国家标准要求。

在中华人民共和国境内销售的电子电气产品上将印有“环保使用期”(EPuP)符号。  
圆圈中的数字代表产品的正常环保使用年限。

合格证

Atenção: conforme lei brasileira nº 11.291, a exposição prolongada a ruídos superiores a 85dB pode causar danos ao sistema auditivo.



© 2025 HARMAN International Industries, Incorporated. All rights reserved.  
 Features, specifications, and appearance are subject to change without notice.



**HARMAN International Industries, Incorporated**

8500 Balboa Boulevard, Northridge, CA 91329 USA

EMEA Liaison Office / Représentant Européen:

Danzigerkade 16G 1013 AP Amsterdam, Netherlands

UK Business Address / Adresse commerciale au R.-U. :

Ground Floor, Westside 2, London Road, Apsley, Hemel Hempstead, Hertfordshire, HP3 9TD, United Kingdom





# SUMMIT SERIES